SPARTAN AIR

SPARTAN SERIES | Air Heater



Spartan Air Heater









INSTALLATION, OPERATION, AND SERVICE INSTRUCTIONS

2+1 year warranty at: www.wallas.fi/takuu

Safety - Safety Instructions	1
Technical information - Supplies and accessories	2
Technical information - Technical information	3
Technical information - Operation description	4
Technical information - Things to note before Installation	5
Installation - Fastening the device	6
Installation - General electrical connections	8
Installation - Product specific electrical connections	9
Installation - Warm air ducting	11
Installation - Camper/RV installation	12
Fresh makeup air intake installation - Air intake installation, air tight compartment	14
Exhaust gas connections - Exhaust gas connections coaxial	15
Exhaust gas connections - Side lead-through 2467	16
Exhaust gas connections - Deck lead-through 5300	17
Exhaust gas connections - Stern lead-through 5400	18
Exhaust gas connections - Insulation kit 2461	18
Exhaust gas connections - Drainage lock 2471	19
Fuel connections - Fuel connections	20
Fuel connections - Fixed tank connection 30011	21
Fuel connections - Separate tank connection 367200	22
Fuel connections - Solenoid valve 30012	23
Fuel connections - Tank external filters 30015, 30016	24
Fuel connections - Tank connection 30018	25
Fuel connections - Selecting the fuel	26
Operation - Device operation	27
Control Panel - Control Panel Installation	29
Control Panel - 3008 Control Panel basic features	30
Control Panel - Wallas Remote application and Control Panel connection	38
Control Panel - Software update	44
Control Panel - Error Codes	45
Important information - Installation check list	47
Important information - Maintenance recommendations	49
Important information - Warranty terms	50
Important information - Disclaimers	51

Safety Instructions

This manual has information on product safety and instructions to reduce risk of accidents and injuries.

	This heater (hereinafter also referred as "unit" and "device") is designed and intended for recreational use.
	We recommend having a Wallas-Marin professional install our products to avoid improper installation that can cause injury or property damage.
	Installation instructions in this manual and country-specific requirements must be followed.
	It is the responsibility of the owner and the installer to determine which requirements and standards apply to specific installations.
	Wallas-Marin offers a 2+1 year/2000 hour warranty. The warranty is not valid if the unit has not been installed according to the manual or the country-specific regulations have not been followed.
	Do not repair, replace or remove any part of the unit unless specifically recommended in the manual. All other servicing should be done by an authorized Wallas-Marin Distributor or Service Center.
	This unit is not intended for use by persons (including children) with reduced physical, sensory or mental capabilities (that could affect a safe handling of the product), or lack of experience and knowledge, unless they have been given supervision or instruction concerning use of the appliance by a person responsible for the safety.
	As with any carbon-hydrogen combusted product, the vessel should be properly fitted with a CO detector, tested regularly and replaced as per the manufacturer's schedule. The installer must ensure there is sufficient ventilation into the indoor space for occupants and system operation.
	Wallas-Marin reserves the right to change or improve its products, and to modify appearances and specifications without notice.

Supplies and accessories

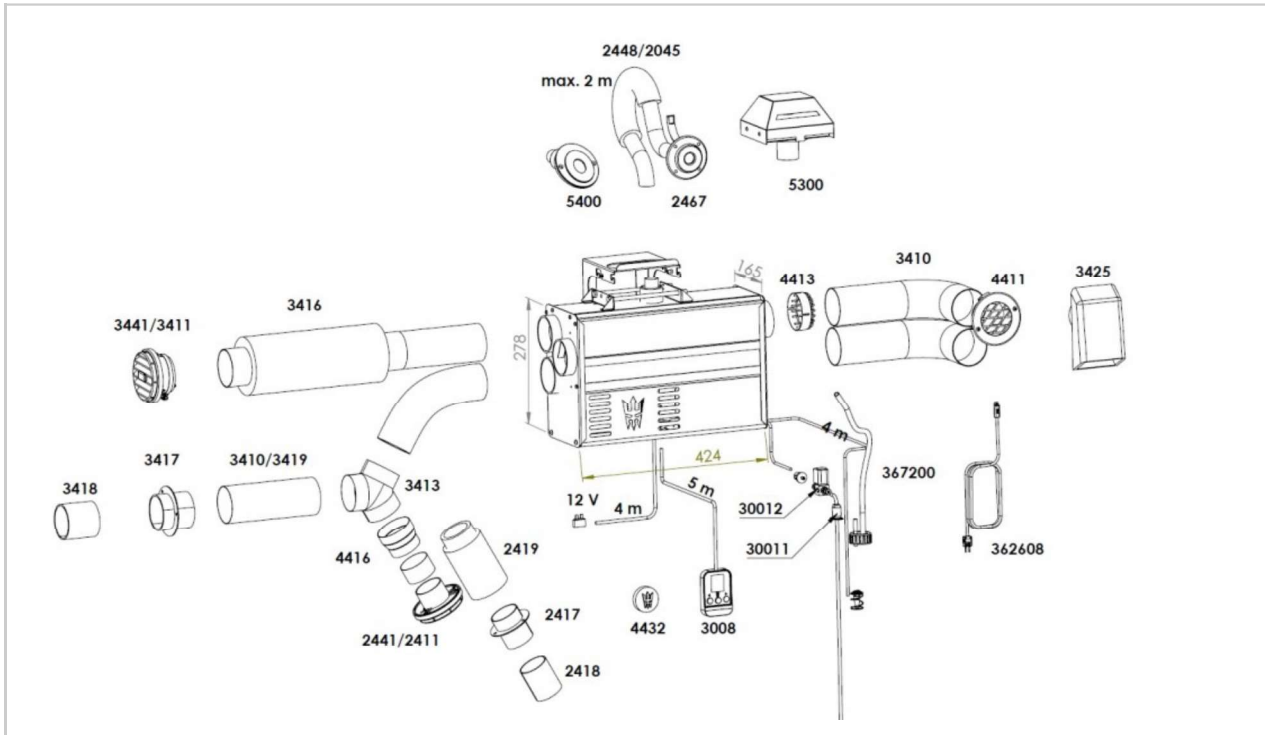

Package contents

Diesel heater
Fuel hose (4m)
Power cable (4m)

3008 Control panel & control panel cable (5m)
362608 Wired thermo sensor
4432 Wireless temperature beacon

List of supplies and accessories

2410 Warm air duct, \varnothing 60 mm
2411 Warm air ventilation grill, \varnothing 60 mm
2417 Bulkhead lead through, \varnothing 60 mm
2419 Insulated warm air duct, \varnothing 60 mm
2441 Warm air ventilation grill, \varnothing 60 mm, white
2448 Coaxial / Duplex exhaust hose, \varnothing 28 / 45 mm
2467 Coaxial / Duplex hull exhaust lead-through, \varnothing 28 / 45 mm
3008 Advanced control panel
3410 Warm air duct, \varnothing 75 mm
3411 Warm air ventilation grill, \varnothing 75 mm
3413 Warm air 3-way divider, \varnothing 75 mm
3416 Silencer, \varnothing 75 mm
3417 Bulkhead lead through, \varnothing 75 mm

3418 Duct extension, \varnothing 75 mm
3419 Insulated warm air duct, \varnothing 75 mm
3425 Water protected inlet grill, \varnothing 75mm
3441 Warm air ventilation grill, \varnothing 75 mm, white
30011 Tank fitting / diesel
30012 Magnetic solenoid valve 12V/0,5 A
362608 Wired thermo sensor
367200 Lead through kit for separate tank
4411 Intake grill 75mm
4413 Inlet grill 75mm
4414 Duct adapter, \varnothing 60/75 mm
4432 Wireless temperature beacon
5300 Deck lead-through
5400 Stern exhaust lead-through, \varnothing 28 / 45 mm

Technical information

Fuel	Diesel oil, light furnace oil, HVO-fuel (Renewable fossil free fuel) HVO EN 15940, B10 EN 16734, D20/30 EN 16709
Operating voltage	12 V DC
Fuel consumption	0,16 l/h - 0,46 l/h (5,4 - 15,5 oz/h)
Heating power	1,4 kW - 4,5 kW (4,700 - 15,300 BTU)
Air flow min (50 mbar counter pressure)	102 m³/h (60 cfm)
Air flow max (50 mbar counter pressure)	226 m³/h (133 cfm)
Power consumption	0,7A - 4,5A (9A during start up, 4 to 8 min)
Dimensions (L x H x W)	165 x 424 x 309 mm (16 11/16" x 12 1/16" x 6 1/2")
Weight	15 kg (33 lbs)
Maximum permitted length of exhaust pipe	2 m coaxial (2448)
Maximum permitted length of fuel hose	8 m
Maximum permitted length of outlet air duct	8 m for upper and middle ones, 5 m for lower outlet
Maximum permitted length of inlet air duct	2 m for each
Minimum area of the replacement air opening	225 cm²
Warm air and fresh air connection	3x75 mm Spartan Air 2x75 mm Spartan Twin
Connections	Solenoid valve Remote control
Suitable Exhaust gas lead-throughs	Recommended: 2467 5300, 5400
Recommended usage temperature	-15 – +30 Celcius Mandatory: Check your local fuel tolerance for freezing temperatures.
ECE-R122 ECE-R10	E17*122R00/06*0001*00 E24*10R06/02*4771*00

Due to physical laws of thermodynamics, Wallas-Marin announces measured values with 10 % tolerance.

The values are defined in Wallas-reference measurement point with maximum ducting lengths. All tubes include four 90° bends.

Operation description

This is a forced air diesel heater without an exposed flame. The heater takes combustion air from outside the boat through the outer coaxial pipe and forces exhaust out through the inner coaxial pipe. The coaxial pipe connects to a common through hull fitting that allows both inlet air and exhaust to pass separately. This process improves efficiency, wind resistance and lowers the minimum power level, while cooling the exhaust system.

Fresh makeup air is taken from desired areas with air intake ducting, e.g. from outside of the boat, inside the cabin or blended. This enables good air circulation and/or cabin air replacement. Taking air from the outside will reduce the heating power, as the outside air is normally cooler. Diesel engine compartment installations are supported by the separate makeup air intake ducts, quarantining the makeup air away from any smells or noxious engine fumes. The heating power can be adjusted freely between high and low output settings by manual control or by thermostat. In hot and/or humid conditions, these heating units can be used for simple fresh air ventilation and circulation.

When starting the device, the glow plug ignites the pumped fuel in the burner bowl. The glow/start and shut down sequences are factory programmed, so - starts and stops are automatically controlled. The fuel pump inside the heater case regulates the fuel feed and the system electronics control the fuel and air mixture to maintain an ideal clean burning process. The temperature sensor inside the burner feels the ignition and lights up the control panel flame indicator to indicate a successful start. When stopping the device, an automatic after cooling process takes place. This process cleans the burner, purging any unburned fuel.

Wallas heaters are built out of the finest corrosion resistant materials to withstand marine conditions.

Things to note before Installation

Heater installation

Country specific regulations shall be followed in any installation. The warranty of products is valid only in installations that are done according to this manual. Wallas recommends that the device be installed by an authorized Wallas service shop or professional installer.

Selecting the installation location

The device shall be installed into a dry space in a protected location. The device must be mounted to a solid surface. When installing, please note that the device needs to be removable for servicing. Connections and location should be made so that the device can be easily disconnected for removal. For maintenance, it is recommend (not mandatory) to leave 200 mm (7 7/8") empty space below the heater for the removal of the bottom cover of the heater.

The heater should be installed vertically level when the boat is on an even keel. The static inclination must not exceed 5°. While the device will tolerate being temporarily tilted to a steep angle (even for some hours), the burner will not yield optimal performance if it is constantly inclined.

Select the place of installation to allow a minimum amount of bending in the warm air ducting. Avoid installing the heater and control panel in the immediate vicinity of any potential water intrusion. If possible, install the control panel on a vertical surface.

In case of water entering the exhaust hose from outside, the heater can be damaged. Water in the exhaust hose might suffocate the heater, leading to toxic gasses.

Installation of pipes, hoses and cables

Power cables, warm air and fuel hoses must be protected in locations where they are susceptible to mechanical damage due to sharp edges or heat. All cables and hoses should have a fluid precluding "drip loop" to prevent water or other fluids from following wires or hoses to the heater. Ensure that the cable connections are not strained.

The exhaust hoses are hot. The exhaust hose can be partially insulated, check instructions from check list.

Installation space

The device can be installed within the heated space or outside of it. If located in an unheated area, heating performance can be improved by installing the an intake air tube to the heated space (warm return air). If located inside the heated area, air refreshing performance can be improved by installing the an intake air tube to the outside air (cold, dry fresh air to be heated). A blend of return air and fresh air for makeup air is usually optimal. Even though the heater is manufactured of water resistant materials, any contact with water will reduce the lifetime of the heater.

It's forbidden to install the heater to a space which may contain gasoline fumes! This may lead to unwanted heater operation, or sudden combustion.

Following sections of manual are presenting important basic installation information but if you have any questions please be free to contact purchasing/local distributor point for more information.

Fastening the device

There are two different ways to install the heater; wall mounting installation and floor mounting installation.

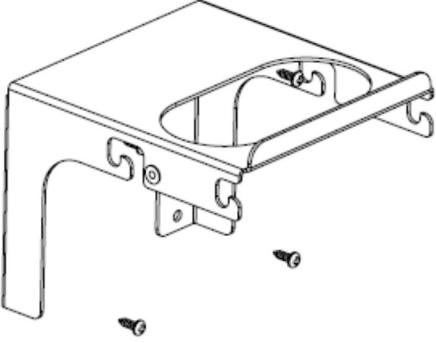
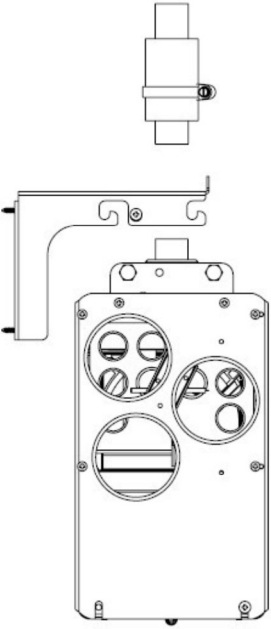
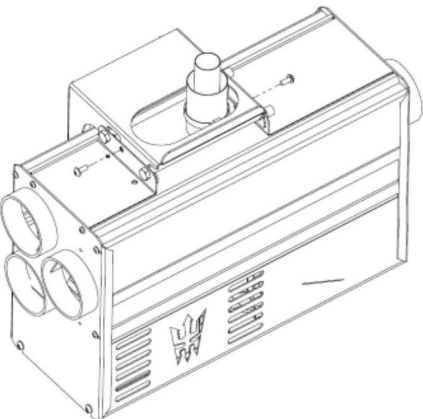
Wall mounting (most common and recommended)	
	<p>Fix the mounting plate with screws to a suitable place and check that the bottom of the heater is in horizontal position. The heater weights 15 kilograms (33,07 lbs) and it must be well fastened to withstand heeling of vessel in all directions. Ensure that the wall is stable enough for the heater.</p>
	<p>Lift the heater into the mounting plate.</p>
	<p>And lock the device with the mounting bolts.</p>

Floor mounting

The heater can be installed to the floor by using "legs". Secure the device to a flat stable surface which is not tilted more than 5 degrees from the horizontal plane. The "legs" and necessary screws can be found from the accessory bag. The heater weighs 15 kilograms (33,07 lbs) and it must be well fastened to withstand heeling of vessel in all directions.

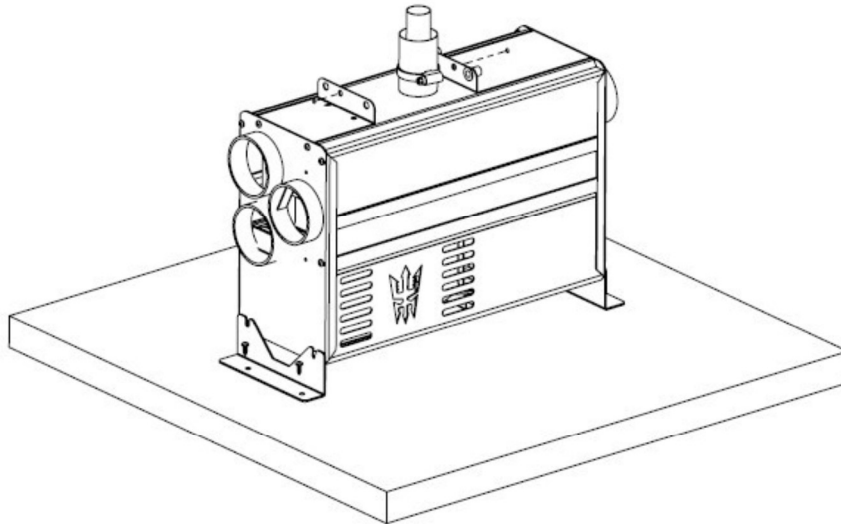

Measures

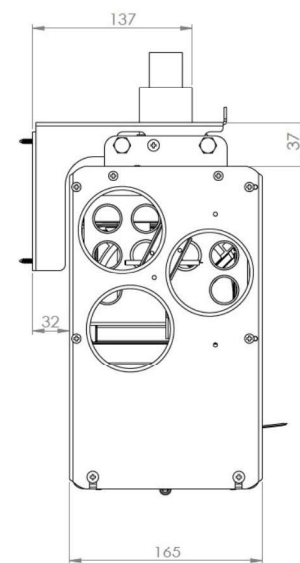
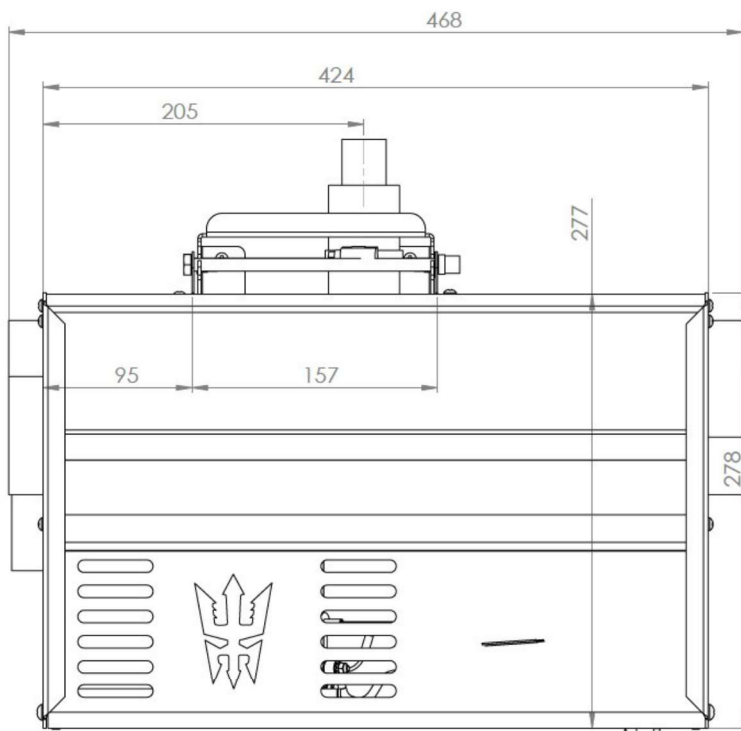

Notice! Ensure that there is enough space for the exhaust hose installation above the heater.

General electrical connections

Safety instructions for wiring the heater



Make sure that electrical cables are not damaged. Avoid: chafing, kinking, jamming or exposure to heat.

Electrical connections and ground connections must be free of corrosion and firmly connected.

Things to note about the connections

All connections must be arranged in the craft so that they can function perfectly under normal operating conditions. Insulate unused cable ends.

The device uses 12 V (nominal) direct current voltage. To minimize current losses, make the power cable as short as possible and avoid joining. The cross-sectional area of the cable is dependent on the length of the power cords. The cross-sectional area of the cable should be consistent all the way from the device to the battery. The maximum length of the power cord is 10 m, based on 6 AWG cable.

The cross-sectional area of the cable

Total length of the power cord (m)	Minimum cross-sectional area of the cable in square mm (US Gauge)
0-4	2,5 (13 or 12 AWG)
4-6	6 (9 or 8 AWG)
6-10	10 (7 or 6 AWG)

If a thicker cable is required, make a separate joint in the power cord. See picture "Electrical connections of the device".



In metal-hulled boat, you must ensure that the device, the flue gas lead-through, the fuel connection, the control panel and all other parts are insulated from the boat's hull. This must be done to prevent electrochemical corrosion and to prevent voltage from being transmitted from the hull to the device or vice versa during electrical faults.

Product specific electrical connections

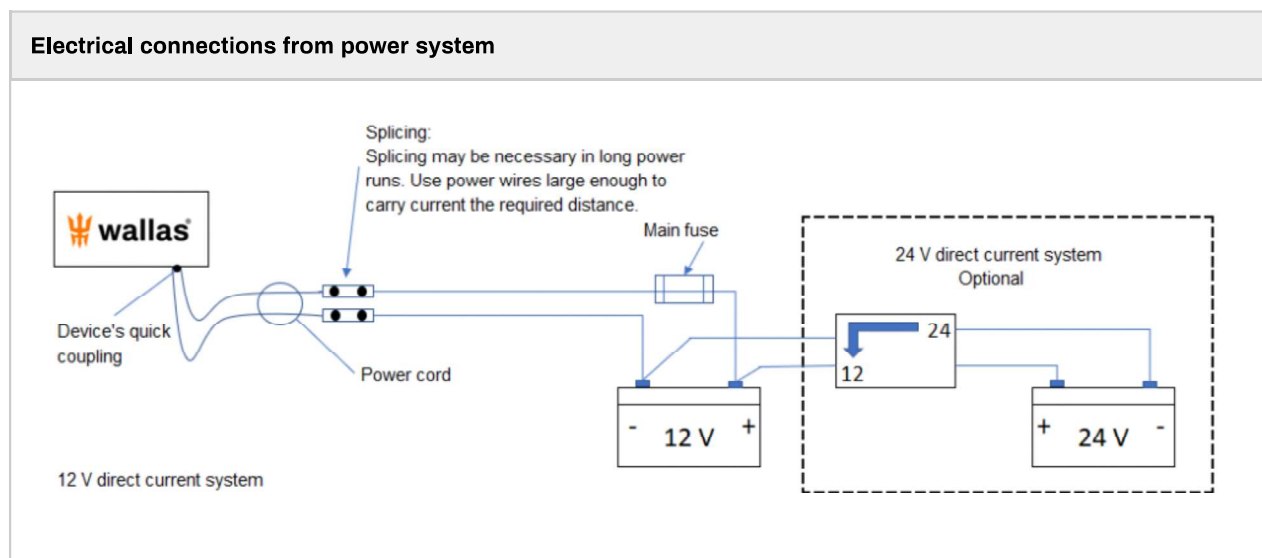

12 V direct current system

Connect the red wire of the power cord to the plus terminal of the battery and the black or blue wire to the minus terminal. A 15 A main fuse must be installed near the battery on the red plus wire of the power cord. See picture above.

24 V direct current system

If the device is to receive power from a 24 V system, always connect a charging voltage reducer through a 12 V battery before connecting the device as shown above.

Without the battery most voltage voltage reducers will not be enough to generate the large amount of current the glow plug requires.

After the 12 V battery, the connection is the same as in a 12 V system. Note, if using remote wire, the remote wire also needs connection to 12V, not 24V.

For DC DC 24/12 converter ask recommendation from your local dealer. There are major differences between them, but typically a converter rated for 25A is required.

Checking the connection

The device consumes the most power when it is starting (glow on). At this time, voltage drop is at it's highest. During the glowing phase, the voltage must not fall below 10 V measured at the quick coupling. See picture above. If the voltage is lower than this, the device may not start.

All wires should to be mounted with smooth bending and equipped with strain relief.

Connection points of the device

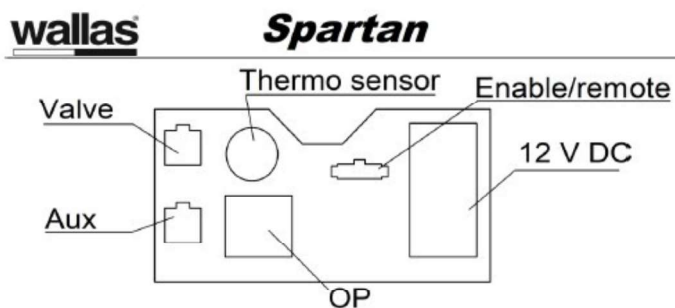

- OP** (not in use)
- 12 V DC** Power cable
- Thermo sensor** Wired Thermo sensor
- Valve** Magnetic solenoid valve cable (accessory)
- Enable/remote** (not in use)
- Aux** (not in use)



A wireless or wired thermo sensor needs to be connected if the heater is used in thermostat mode. As a primary room temperature sensor, the wireless sensor is recommended, because it is the most accurate sensor and portable. Our recommendation is to connect the wired sensor also (even if it is not perfectly located in the cabin), as an important back up for the wireless sensor. If the battery of the wireless sensor fails, the system will automatically default to the wired sensor. If the heater does not have any sensors connected, then room temperature monitoring is not available, the heater will go to safe mode and run only at minimum power level.

Wired thermo sensor (362608)

Wireless sensor (4432)

Accessory installation:

For installations see page Solenoid Valve (Wallas code 30012)

Warm air ducting

Warm air ducting of the heater

It is important to plan the proper routing of the duct and the locations of the air vents. It is good to locate the heater as near as possible to the area being heated. Avoid the use of sharp bends in the ducting and keep overall bends to a minimum.

Outlet ducting

Heated air is distributed through the boat with **3410** ø 75mm duct. Multiple outlets can be installed by adding **3413** ø 75mm "Y" fittings leading to various locations. All duct to "Y" and duct to vent connections should be clamped.

The **3411** air vents are adjustable for direction and flow and located at each duct termination point. It is important that sufficient flow is allowed by the installed vents to maintain (limit) the heater temperature. To ensure this for some applications, the adjustment flap of the vent in the bigger heated space, will be removed. Too much resistance in the ducting (too many flaps closed) and the heater may overheat and shut down.

To minimize the loss of heat energy, any long runs and/or runs in areas that do not require heating can be insulated using **3412** insulation. Insulation nearer the heater will be more effective than insulation at the far ends of duct runs.

Inlet ducting and makeup air

The heater can take air for heating (makeup air) from either the heated area (return air) or from outside the boat (fresh air). In most cases, a mixture of both is the best choice. The upper of the intake air ducts should be installed to take fresh air from outside and the lower return air from inside of the boat. Intake air grilles **4411** should be installed in the entry of the inlet ducts to preclude foreign objects from entering the heater. Protect the outside grill from splash water, spray etc. There has to be minimum 225 cm² (35 square inches) ventilation/cooling air opening in the space where the heater is installed.



Make sure that intake hoses are installed so that there is no possibility to suck exhaust- or other fumes to the heater, it may lead carbon monoxide poisoning which has severe consequences to health or may lead to death.

Silencers





There are available silencers **3416** (75mm) and **4421** (90mm) for the air hoses. Especially if the inlet hose is taking air from inside from the sleeping space, and/or warm air outlet is blowing the air to the sleeping space the silencer is recommended to use to maximize comfort.

Silencers reduce the sound level 50-75%.

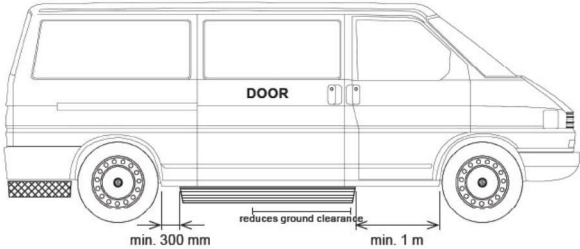
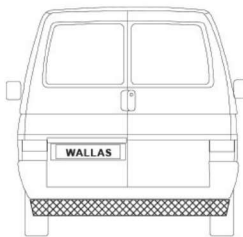
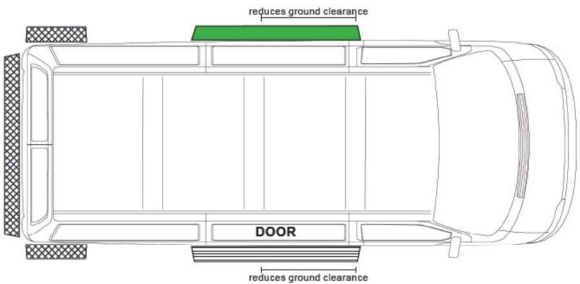

Camper/RV installation

Location of the exhaust gas hose

Location in the underframe	
	
	<ul style="list-style-type: none">  = <u>Good installation place</u>  = <u>Possible installation place</u>  = <u>Forbidden installation place</u>

When selecting the location for installing the chassis installation kit (4310), the internal layout of the vehicle and routing of the exhaust gas and intake air hoses should be taken into account. Try to keep the hoses as short as possible. Also keep in mind that the exhaust gas hose becomes hot.

A free flow of air past the exhaust gas hose must be ensured at all times. Install the end of the exhaust gas hose on a straight surface, flush with the vehicle's side line. Avoid corners and cavities where wind pressure may disturb the unit's operation. Also bear in mind that when installed in the middle of the vehicle, the exhaust gas pipe will reduce ground clearance the most.

The minimum distance of the exhaust gas pipe from the fuel tank's filler hole is 400 mm (16").

The front edge of the exhaust gas hose must always be installed flush with the vehicle's side line, it must not be under the vehicle. The minimum distance from the rear tyre of the vehicle is 0.3 metres, while the minimum distance from the front tyre is one metre. The exhaust gas hose must not be installed at the rear end of the vehicle.

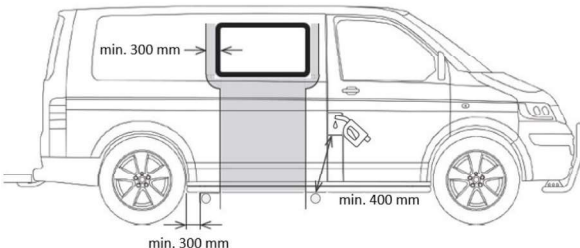
Location under a window	
	<p>The minimum distance of the exhaust gas pipe from the fuel tank's filler hole is 400 mm (16").</p> <p>The front edge of the exhaust gas hose shall not be installed under an opening window or closer than 300 mm to the window's edges. If the exhaust gas hose has to be installed near an opening window, the window must be prevented from opening or fitted with a switch that prevents the unit from being used when the window is open.</p>



The minimum ground clearance shall not be exceeded.

Make sure that there is open way to the point of jack up.

Installing the exhaust gas hose

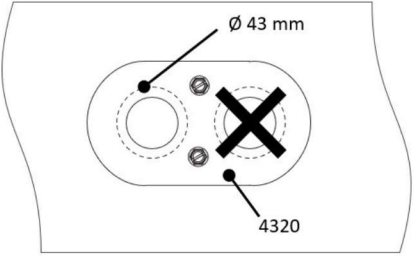
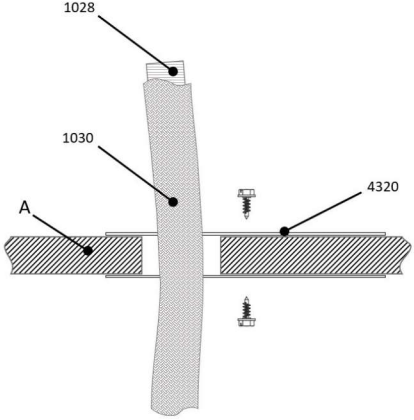
	<ol style="list-style-type: none"> 1. Drill one approximately $\varnothing 43$ mm hole for the hose, as illustrated. 2. Install the bottom penetration cover plate set (4320).
	<ol style="list-style-type: none"> 3. Insulate the exhaust gas hose (1028) with the fiberglass sleeve (1030). <p>If the floor structure of the vehicle at the location of the exhaust gas hose is not heat resistant, remove part of the insulation and replace it with heat-resistant material.</p>
<p>A Vehicle floor structure</p>	

Fixing to the vehicle bottom

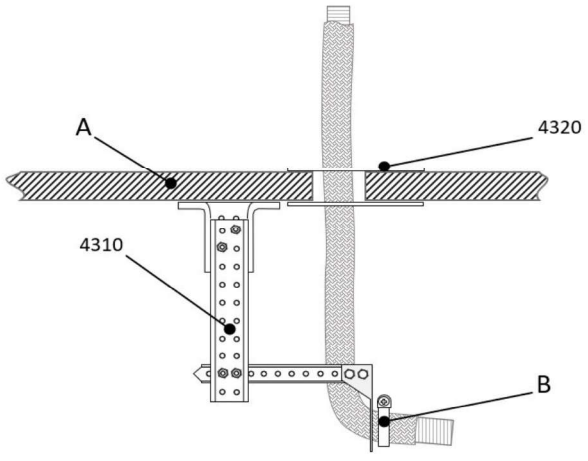
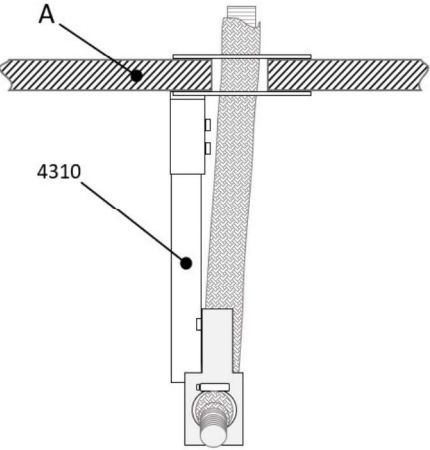
<p>There are many possible ways to install the exhaust gas hose to the vehicle's bottom structure. The basic chassis installation kit (4310) can be used to install the exhaust gas frame to most vehicles. Installation kit for vehicles is sold separately.</p>	
	
<p>A Vehicle floor structure B Hose clamp 20-32 mm</p>	<p>A Vehicle floor structure</p>

Air intake installation, air tight compartment

Fresh makeup air installation

Inlet ducts must be installed. It is important to install intake ducts and not to take fresh makeup air from the space where the heater is installed. Fresh make up air can be taken from living space and/or outside the vehicle/boat.

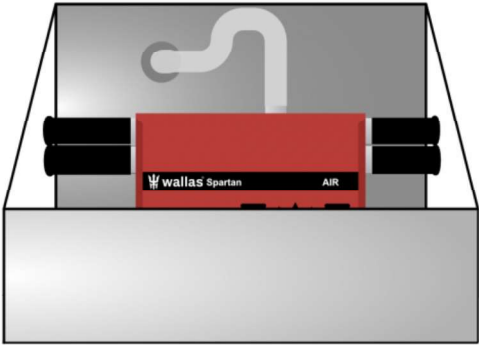
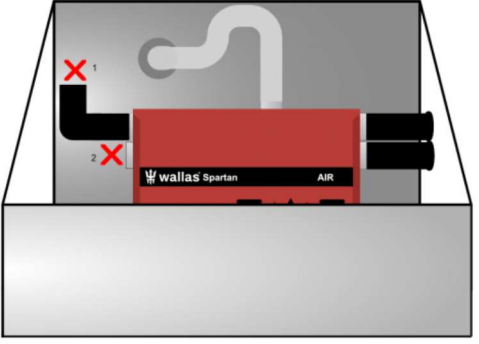
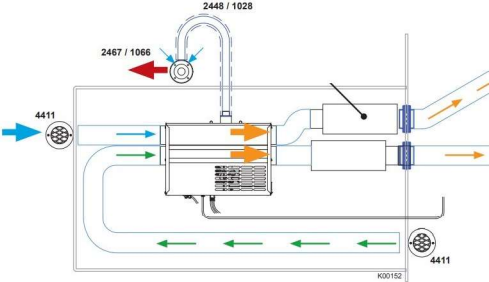
<p>Correct installation</p> 	<p>Correct air intake installation</p> <p>In any case of leakage of dangerous exhaust gases from the heater unit the gases cannot be circulated through the living area due to closed air intake installation. Make sure that the space where air is sucked is not enclosed or sealed. It is advised to take air from inside the living space and/or outside.</p> <p>It's forbidden to install fresh makeup air intake ducts to a space that may contain gasoline fumes or any other dangerous fumes or gases.</p> <p>Make sure that exhaust gases can never mix into fresh air intake.</p>
<p>Incorrect installation</p> 	<p>Incorrect air intake installation</p> <p>In this incorrect installation noxious gases will be sucked to the inlet of the heater unit and circulated into the living space, if there should be a leakage of dangerous exhaust gases to the compartment. This may lead to severe injuries and death.</p> <p>1. Incorrectly lead duct, lead to the heater space. 2. Incorrect installation, no air duct.</p>
<p>Installation example</p> 	<p>Installation example</p> <p>Both air inlet ducts are lead outside the heater compartment.</p>

	<p>Exhaust gases are hot and toxic.</p>
---	---

Exhaust gas connections coaxial

Exhaust gas lead-throughs

It is important to choose right part for right purpose. Coaxial exhaust gas lead-throughs **2467, 5300** and **5400** are recommended for Wallas unit. The \varnothing 28/45 mm lead-throughs fit the exhaust gas hose **2448**, providing maximum wind tolerance. All exhaust gas lead-throughs are stainless steel.

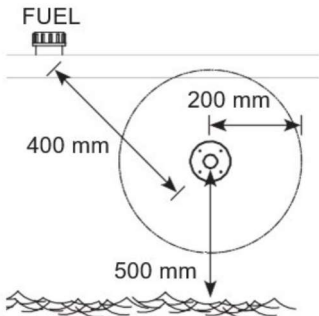
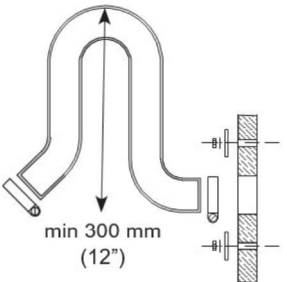
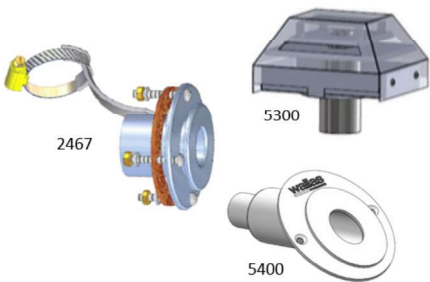
<p style="text-align: center;">Safety distances</p> 	<p>Location</p> <p>Air must always flow freely past the lead-through. Install the lead-through on a flat surface. Avoid corners or recessions where wind pressure can disturb the functioning of the device.</p> <p>The minimum distance of the lead-through from the fuel tank's filler hole is 400 mm (16").</p> <p>The minimum distance of the side lead-through from the surface of the water is 500 mm (20"). Especially in sail boats it should be noted that the lead-through must never be submerged.</p> <p>It is recommended to place the lead-through in the side as far back as possible or directly in the transom.</p> <p>Never place lead through near cabin fresh air intake. Make sure that exhaust gases can never mix into fresh air intake.</p>
<p style="text-align: center;">Goose neck</p> 	<p>Installation</p> <p>When preparing the installation cut-out for the lead-through, it is a good idea to use the lead-through as a model for the cut-out; especially if the lead-through is circular.</p> <p>If necessary, seal the installation cut-out with silicone in addition to the lead through seal. Note! Do not use silicone on a wooden boat.</p> <p>The side lead-through must always be equipped with a so-called goose neck section. The goose neck will effectively prevent splash water from getting to the device. The highest point of the goose neck must always be above the surface of the water.</p> <p>The device will go out, if the exhaust gas lead-through is submerged.</p>
	<p>Other things to note</p> <p>Exhaust gas is hot. Always ensure that there is nothing that is susceptible to heat damage within 200 mm (8") of the effective area of the exhaust gases (e.g. ropes, fenders or the side of another boat).</p> <p>All lead-throughs raise the temperature of their surroundings. A wooden deck, in particular, may dry due to the heat. Remember that the surface of the lead-through is hot during use.</p> <p>An exhaust gas tube with a length of more than 2 meters (7') has to be equipped with a drainage lock 2471 (condense water) located to the lowest point of the tube.</p> <p>The exhaust gas pipe must be made of stainless steel. If necessary, seal the connections between the exhaust gas pipe and the lead through with heat-resistant silicone.</p> <p>When installing the lead-through to the stern side or to otherwise leaning position, be sure that the water do not stuck the exhaust. Drainage lock 2471 available for this purpose.</p> <p>In metal-hulled boat, ensure that the device, the flue gas lead-through, the fuel connection, the control panel and all other parts are insulated from the boat's hull.</p>



Exhaust gases are hot and toxic.

Side lead-through 2467

Assembly instructions

A side lead-through is installed in the side of the boat or in the transom. In sailboats it is recommended to install it in the transom. The installation always requires a so-called goose neck. Make the necessary installation cut-outs and spread a suitable sealing agent on both sides of the seal and on the screw holes. This will ensure that the connection is waterproof.

Side lead-through **2467**

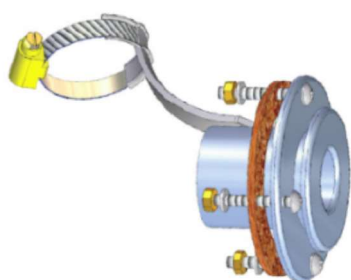

Length difference of the pipes

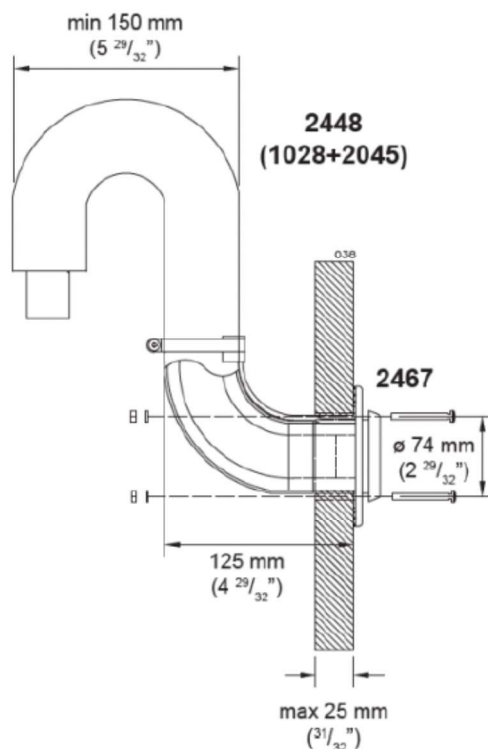
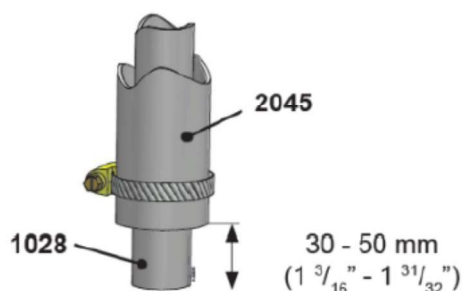

The **1028** exhaust gas pipe must be 30-50 mm (1 3/16" - 1 31/32") longer than the **2045** inlet pipe. This way the exhaust gas pipe will stay in place in the lead-through more firmly. The measurement depends on the overall length of the piping.

Side lead-through **2467** installed. The installation cut-out is \varnothing 50 mm (1 31/32") and the screw holes are 4 x \varnothing 6 mm.

2467 package content

1 pcs	Side lead-through	
1 pcs	Accessory bag 17679	
	Fastening screw TORX M5 x 40 mm	4 pcs
	Nut M5	4 pcs
	Washer 5,3 x 10 mm	4 pcs
	Hose clamp 32/50 mm	1 pcs
	Gasket 87/61x4mm	1 pcs

Deck lead-through 5300

Installation instructions

Installation cut out is \varnothing 50mm and the screw holes are \varnothing 6 mm x 4 pcs.

Deck lead-through 5300

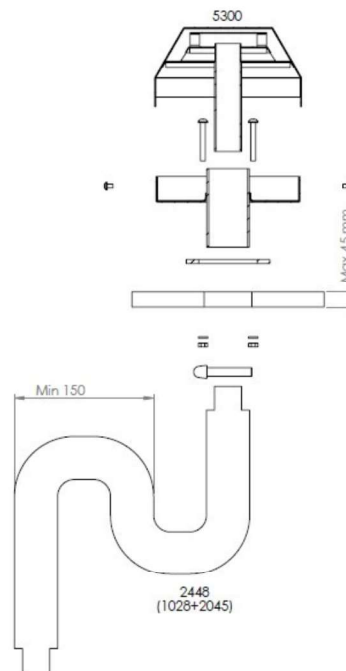
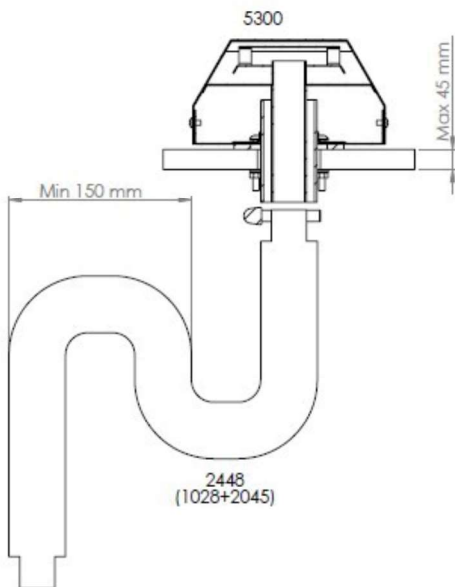
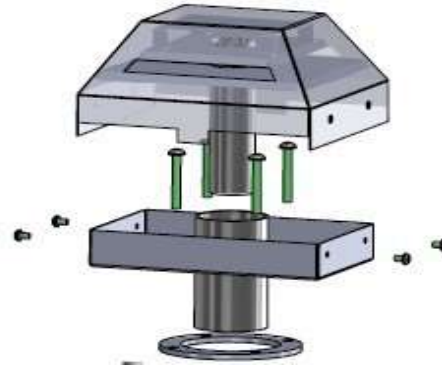

5300 package content

1 pcs	Deck lead-through	
1 pcs	Accessory bag 17679	
	Fastening screw TORX M5X40 Nut M5 Washer 5,3 x 10 mm Hose clamp 32/50 mm Gasket 87/61x4mm	4 pcs 4 pcs 4 pcs 1 pcs 1 pcs

Stern lead-through 5400

	Installation instructions
	Follow instructions for the exhaust gas lead-throughs.
Exhaust lead through for negative transom. Designed especially for sail boat's stern.	

Insulation kit 2461

An insulation kit (2461) must be used to insulate the lead-through from the boats metal hull. The insulation kit insulates the exhaust gas lead-through and the device from each other. In fault situations the insulation kit prevents electric circuit running between the metal hull and the device. This could result the oxidation or malfunctioning of the devices circuit board and the circuit board would be damaged.

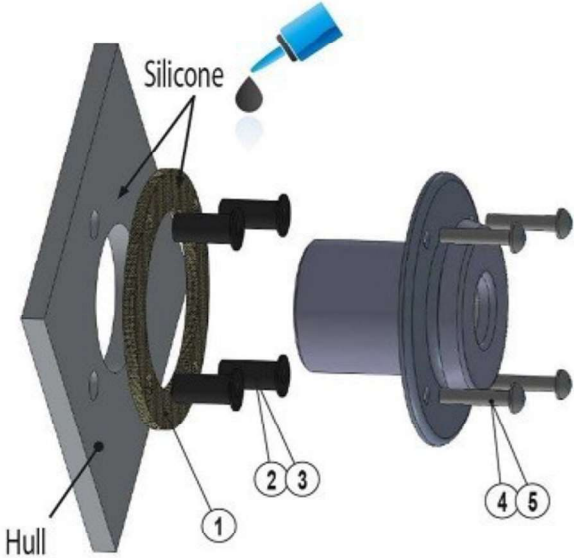
	2461 insulation kit includes:		
	Part #	Definition	Amount
	1	Gasket	2 pcs
	2,3	Rubber nut M5 x 0,8 x 39,8	4 pcs
	4,5	Screw M5 x 40 A2	4 pcs
		Installation instructions	1 pcs

Drainage lock 2471

It is recommended that a drainage lock is installed if there is a risk of condensed or splash water entering the exhaust.

Drainage lock 2471

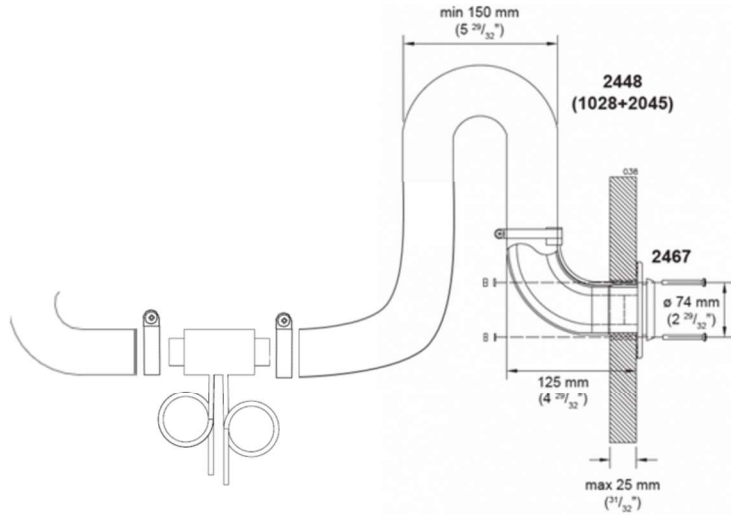
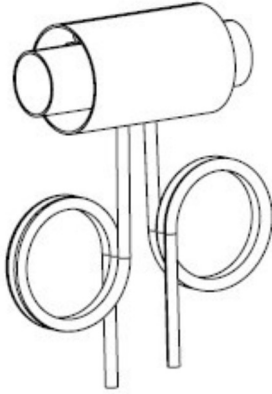

If necessary, a drainage lock can be installed into the exhaust pipe of a hull lead-through, but note the drainage lock must be positioned after the gooseneck.



When washing the boat with a pressure washer, never aim the water jet at the lead-through as the device may get wet.

Fuel connections

The standard length of the supplied fuel hose is 4 m (max 8 m). Cut the fuel hose to a length suitable for installation.

The lift height of the pump should be less than 2 m; preferably 0.5-1 m. The fuel pipe must always have a Wallas filter, either in-line or in the fuel tank. Only one filter should ever be in the system. The fuel filter can be installed either near the device, near the tank, or in another location where it can be easily checked and replaced, when necessary.

Diesel engine fuel filters and/or separators are not approved for use. All soft connections should be made with rubber or silicone hose which is resistant to fuel. When joining with rubber connectors, tubing ends should butt against each other.

Fuel lines other than those supplied by Wallas should be small bore (2-3mm) and must be qualified for suction use. Typical rubber fuel hose is not qualified for suction use, having a soft, collapsing inner wall lining. Please contact your Wallas dealer/distributor if non-standard fuel lines are being considered.

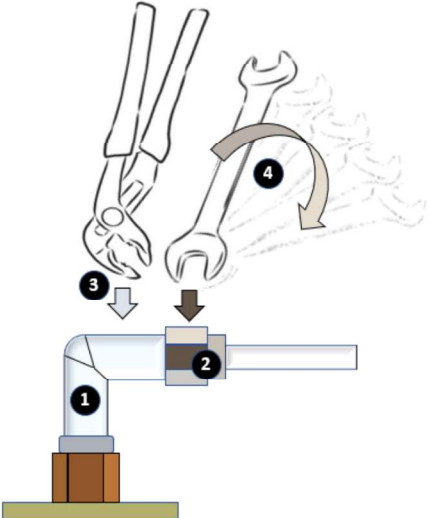
Connection to a heater	
	<ol style="list-style-type: none"> 1. Pump inlet elbow 2. Fuel line nut 3. Use pliers to hold the pump inlet elbow steady 4. Tighten the 12 mm fuel line nut. Tightening torque is 19 Nm (14 ft/lbs) <p>Note! The joint has to be very tight to prevent air leaks.</p>

Country-specific requirements

The standard fuel hose is plastic. Please observe country-specific requirements with regard to the material of the fuel hose/pipe and the fuel filter. The inner diameter of a new replacement hose should be equal to the inner diameter of the plastic hose. Copper pipe **300692** and metal filters **30016** are available as accessories. Ask local requirements from your distributor.

Fuel feed

If the lift height exceeds 2 m, the fuel feed must be checked and, if necessary, adjusted.

The fuel feed must also always be checked, if parts of the fuel system, such as the pump or the electronics card, have been replaced. Fuel system adjustments are device specific. These adjustments should only be carried out by an authorized service shop.

Connection to a fixed tank supplying other diesel consumers

The Wallas device must have a dedicated (not shared) connection with a fuel filter outside the tank.

Connection to a separate tank

Cap run-throughs and sintered in-tank filters are used on plastic tanks. The fuel tank should be mounted securely.

Fixed tank connection 30011

Installation instructions for tank connection 30011

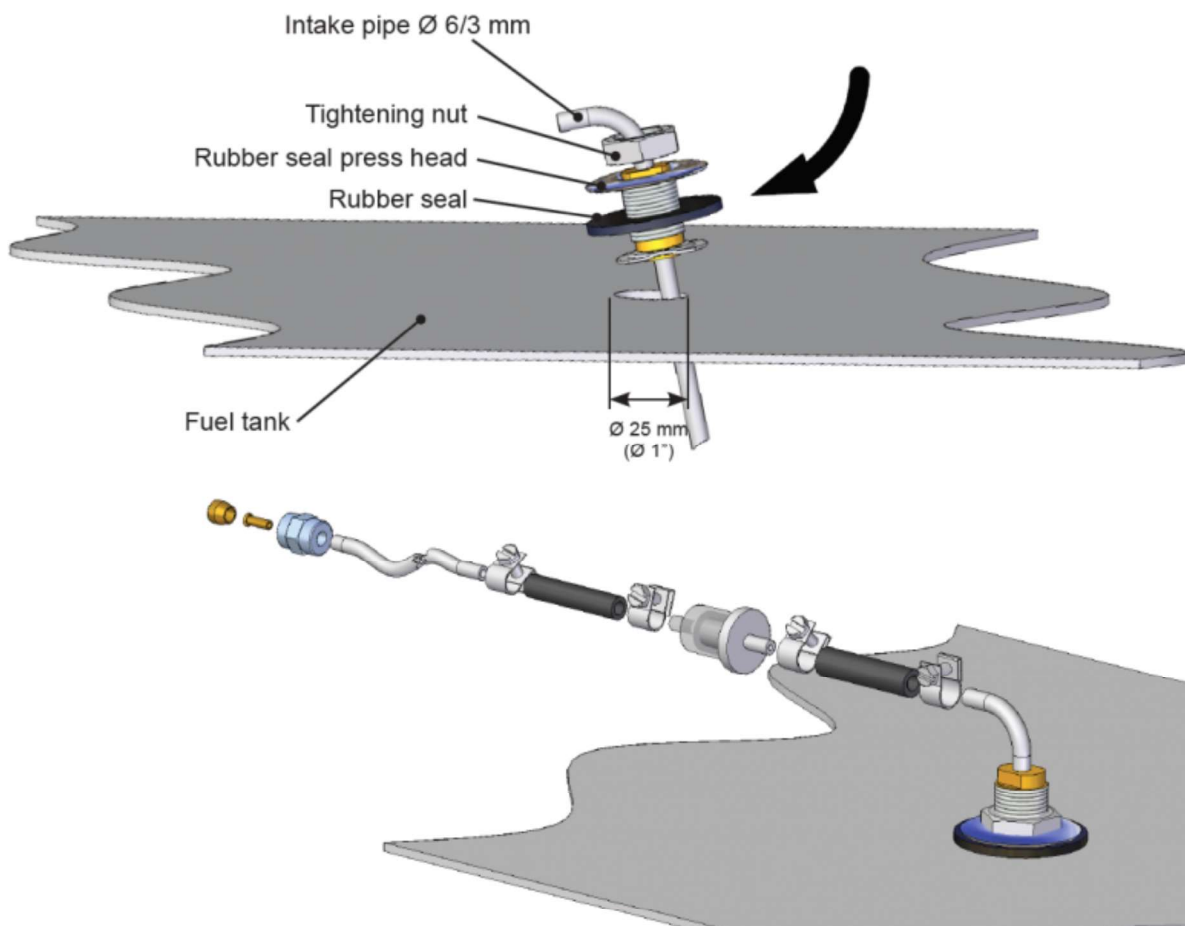

1. You will need to make a Ø 25 mm (1") hole in the upper surface of the fuel tank. Choose the location of the hole so that when the fuel tank tilts the end of the intake pipe will stay in the fuel even if the tank is not full. If the end of the intake pipe does not reach the fuel, the device will quickly choke on the air in the fuel system and that can cause malfunction to the system.

2. Cut the fuel intake pipe (Ø 3.2/0.8 mm) to the appropriate length. The end of the pipe must not touch the bottom of the tank in order to keep water and sediment from the system. It is recommended to cut the pipe short enough to leave the engine intake pipe at a lower level. This way the device cannot empty the tank.

3. Install the pipe straight end first and angle the two "ears" at the bottom of the threaded barrel inside the hole and then align the threaded barrel vertically so the ears are hooked on the underside of the tank top. Carefully slip the rubber washer over the bent pipe end and over the threaded barrel, followed by the metal washer and the nut. Thread the nut to the threaded barrel and tighten, sealing the fitting to the top surface of the tank.



If the device uses the main tank of the boat, note that the device cannot take the fuel from the same fuel output line as the engine of the boat.

Separate tank connection 367200

If the fuel will be taken from a separate tank, a tank connection **367200** must be installed.

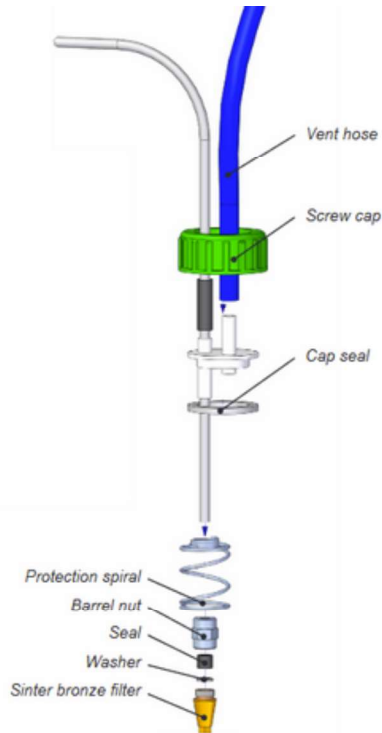

Wallas fuel tanks

Wallas fuel tanks are sold as accessories.

Volume	Length x height x width	WALLAS code
5 l	200 x 300 x 130 mm	2024
10 l	380 x 195 x 210 mm	2027
33 l	500 x 230 x 350 mm	4030
130 l	800 x 400 x 600 mm	4130

Solenoid valve 30012

The solenoid valve **30012** (available as accessory) prevents the tank from emptying in case the fuel system fails. The fuel filter should be installed before the solenoid valve.

Our recommendations in the following installation configurations:

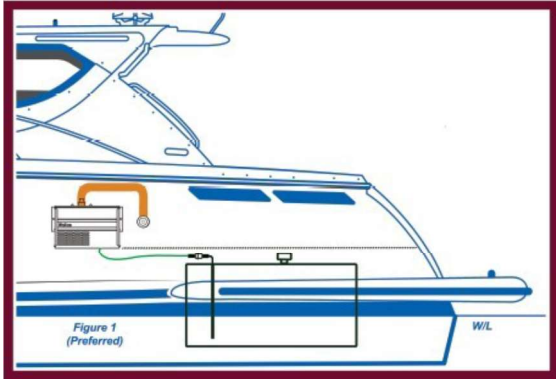
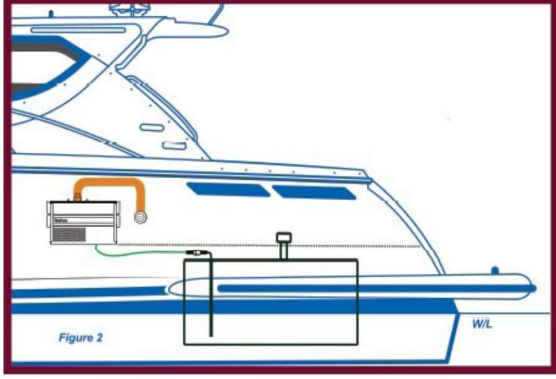
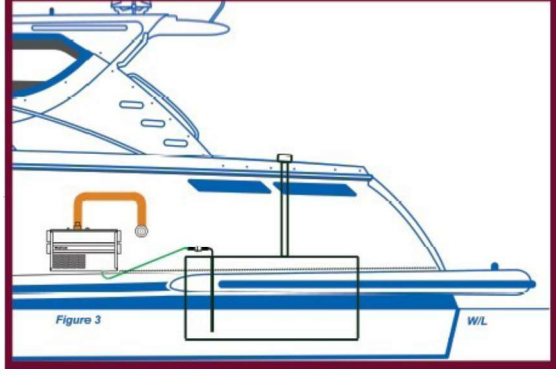
<p>Preferred installation layout (solenoid valve 30012 is not required)</p>	 <p>Figure 1 (Preferred)</p>
<p>Solenoid valve 30012 is recommended</p>	 <p>Figure 2</p>
<p>Less desirable installation arrangement (solenoid valve 30012 must be installed)</p>	 <p>Figure 3</p>



If the fuel level in the tank is above the device, a solenoid valve 30012 must be installed in the fuel line immediately after the tank lead-through.

Tank external filters 30015, 30016

Assembly instructions

Filters can be installed in a $\varnothing 5$ or $\varnothing 6$ mm plastic tubing or 1/8" metal pipe. Ensure that the fuel pipes are clean before installing the filter. There must be no debris or impurities between the pump and the filter as they will clog the pump. The filter type must be selected according to the operating conditions and country-specific requirements.

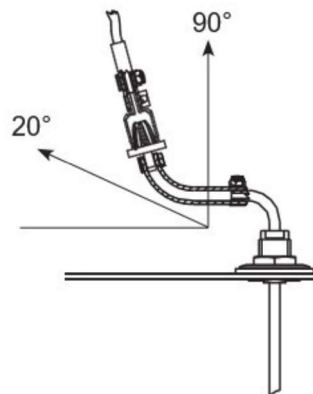
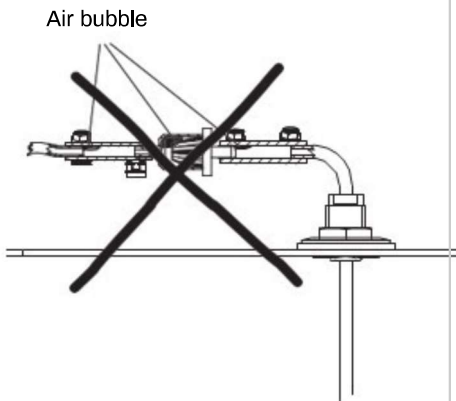

Fuel filter 30015

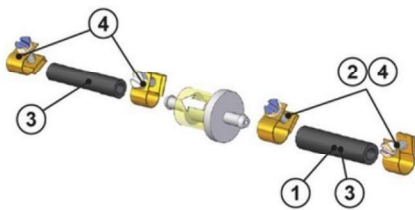

The filter is supplied with the device.

The filter can be installed directly in the **30011** tank connection by using a $\varnothing 6$ mm rubber hose (1) and 10 mm hose binders (2). Alternatively, the filter can be installed between two $\varnothing 5$ mm fuel hoses with $\varnothing 5$ mm rubber hose (3) and $\varnothing 8$ mm hose binders (4).

Install the filter in the direction of the arrow on it.

Fuel filter 30016 (accessory)

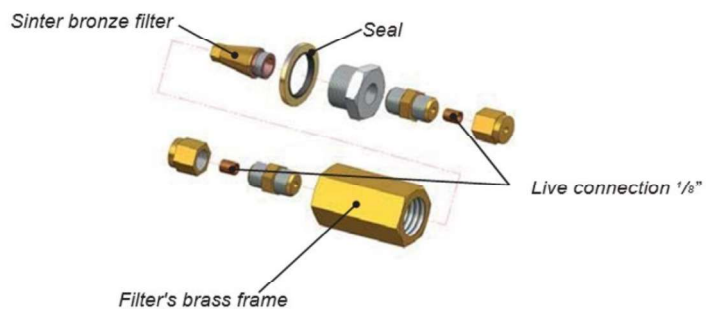
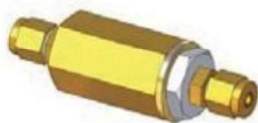

This filter is used in countries where a metallic fuel transfer system is required. A 1/8" metal pipe is used for the installation.

Tank connection 30018

Einon® (30018) is a leak-proof intake fuel line.

Getting Started

Parts needed in installation are put in right order and are connected together with a wire. You shall never cut the installation wire, you'll need it when installing the intake pipe. (Installation without the wire is not possible).

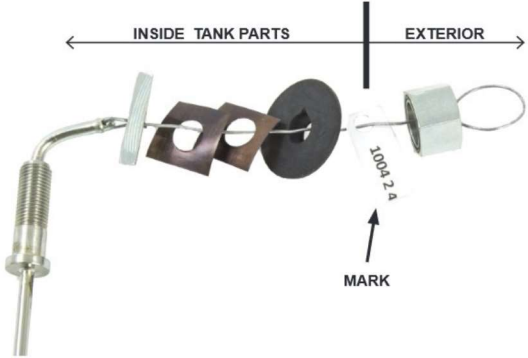
	<p>Installation instruction for 30018 (camper installation)</p> <ol style="list-style-type: none"> 1. Make sure that the fuel tank is empty enough. 2. Search about 4 cm flat section from the fuel tank where you can drill a 13 mm diameter hole. 3. Clean the selected area of protection grease and clean also other possible dirt. 4. Drill a hole. 5. Remove the burr from hole (inside and outside). 6. Figure out without installing for Einon ® (30018) suitable bending and length. 7. Cut the pipe end diagonally and remove burrs. 8. Install the cut and bent intake pipe through the drilled hole into the tank. 9. Push through the hole into the tank all the other interior parts (up to the mark), keep the order of parts as they are mounted to the wire. 10. Pull from the wire until the Einon ® (30018) threaded part is outside of the tank. 11. Turn the Einon ® (30018) to the correct position and tighten the tank external part (nut). 12. Attach the fuel line to the Einon ® (30018).
--	---



For camper installation only! Materials are not stainless steel.

Selecting the fuel

When selecting the fuel type, pay attention to the temperature limits of each particular fuel. The limit values provided here are to be treated as guidelines. Confirm the actual temperature limits from your local fuel supplier.

- HVO-Diesel, Diesel, summer grade, temperature must not fall below -5 °C.
- HVO-Diesel, Diesel, winter grade, temperature must not fall below -24 °C.
- Diesel, arctic winter grade, temperature must not fall below -40 °C.

If the temperature drops lower than the minimum level, paraffin may form in the fuel. This may result in the fuel filter and pump being clogged. The clog will dissolve only if the fuel temperature rises clearly over 0 °C.

For fuel additives and life length of the fuel ask information from your fuel supplier.

Recommended fuels

As one of the leaders in ultra-low-emission burner technology, Wallas is committed to clean combustion processes.

With our laminar flow Green Boost burner technology and adaptive software, our burners have ultra-low emissions, including exceptionally low CO₂ and NO_x levels.

All Wallas-Marin diesel heaters and stoves use diesel, renewable diesels (HVO 15940), or paraffin oil (kerosene) as fuel.

These include:

Today's road and boat diesels (EN590), renewable (HVO 15940).

We don't recommend the use of FAME (Fatty Acid Methyl Esters) fuels.

The methyl esters in biodiesel are hygroscopic. This means that they can absorb considerably more moisture than petroleum-derived diesel and hold this in suspension in the fuel. Petroleum-derived fuels absorb considerably less moisture by comparison and tend to shed water as a separate layer at the bottom of storage tanks. When water is able to contaminate diesel, it provides conditions suitable for microbial growth and can lead to diesel bugs, molds, yeasts and bacteria spreading throughout the fuel. FAME is bio-degradable and is an ideal source of nutrients for microbes. If contamination is left untreated, it can damage the fuel permanently.

Source: <https://www.crownoil.co.uk/guides/fame-biodiesel-guide/>



Confirm the actual temperature limits for the fuel you are using from the fuel supplier.

Device operation

Ignition

The start-up process and heating is automatic.

The heater will ignite when the heaters Start/Stop Icon is selected and confirmed the selection by holding the Select Button down for 3 seconds. "Starting" will appear on the screen, indicating that the heater is on and in its Starting mode.

The light orange combustion light will light up when the burner flame has been ignited and the combustion has stabilized (in about 5 min). Heater will be fully operational about 10 minutes later. About 12 minutes after first giving the start command, the system controls will be handed over to the user, signaling the end of the Start sequence.

First start-up and lock

After installation or maintenance, if the fuel line is empty, the heater may not start at the first attempt. Start-up phase with empty fuel line may be longer than normal and might take up to 15 minutes. If the heater does not ignite, the orange combustion light will not appear and error information is shown. Shutdown the heater. The device cannot be restarted until the cooling phase is completed. When the cooling phase is finished, switch the heater on again. If the device does not start after two attempts, it cannot be started again: the heater will lock itself and lock icon will appear. Investigate, find and follow error solving instructions to resolve the problem prior to further use. After resolving the problem, remove the lock (instructions in the control panel section) and start the unit. Depending on the length of the fuel hose, the heater may have to be started several times during priming. Keep an eye on how the fuel moves in the fuel hose while starting up the heater. Fuel should move about 15mm (5/8") each time the fuel pump clicks, and should not fall back toward the tank between clicks. If fuel motion is weak or falls backward, check the fuel nut for tightness and tighten if needed.

Adjusting the heat

Room temperature setting can be done in thermo control mode, or you can adjust heater output power level directly in manual mode. Instruction for how to select modes and how to set the target temperature or power level are explained in the Control Panel section in detail. In settings you can select your preferred temperature units (Celsius or Fahrenheit).

Note! The system mode that was used last before shutdown will be the same mode when the heater is started again. Choosing the mode must be done before starting.

Thermo control mode

In Thermo Control mode the desired target room temperature can be set. Target temperature will be maintained automatically, through power level changes and pausing when necessary.

Pause feature (Thermo Mode only)

The pause feature automatically turns the heater off in the following conditions: The temperature remains +2 C° (3 F°) above the set level for 1/2 hour due to local ambient conditions and the power has been at 1% for that whole time. Pause mode can be delayed temporarily by slightly increasing the target temperature. If the heater is in Pause mode, "Paused" will appear on the screen. During pause, the fuel pump stops and the system runs a normal cool down period and then goes silent. The heater will re-start heating again automatically if the cabin temperature falls 2 degrees C (3 F°) below the set target temperature. Heating can be turned on by increasing the target temperature while in pause.

Manual mode

The power can be adjusted manually. To enable this function select manual mode from main menu when heaters is off. After the heater has been started up, the power can be adjusted by pressing arrow buttons to any of six power levels. To switch between modes turn the heater off and start in the desired mode.

Air boost

Air boost maximizes the air volume for quick defrosting and drying, but does not change the set temperature or heating power level. Air boost can be activated either in Manual or Thermo Control mode (only while the system is heating). The orange Air boost icon indicates that the air boost is activated.

Ventilation

Ventilation mode blows fresh air without heating with 6 blower speeds. Ventilation mode should be chosen prior to start the heater. See Control Panel section for mode detailed usage information.

Shutdown

You can shutdown the heater any time by pressing the Select button down for more than 4 seconds. White color in Power on/off icon indicates that unit is shutting down.



Remote control

The heater can be controlled with IOS or Android WALLAS REMOTE APP in local network or over the WLAN network. Read instructions from APP manual.

Control Panel Installation

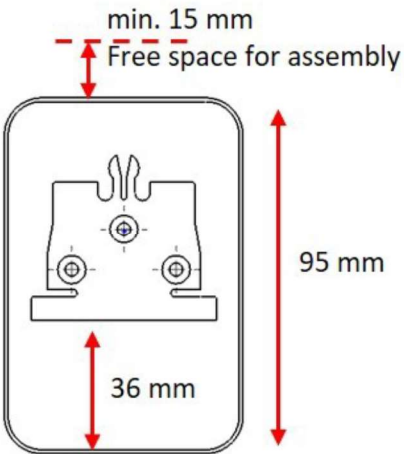
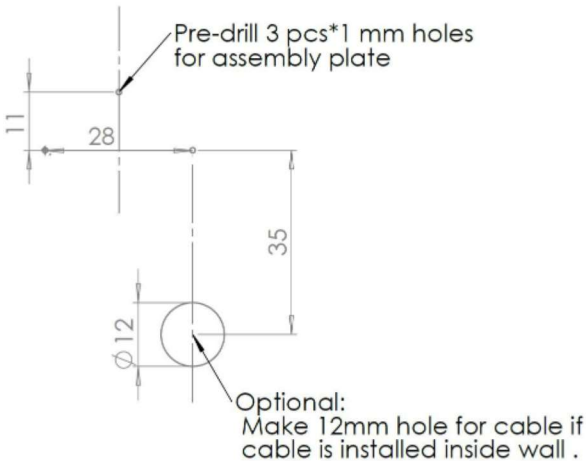
3008 and 3009 Control Panel cable can be assembled as a surface mount or behind wall.

Surface mount, cable visible	Cable hidden behind the wall
	<p>Install assembly plate to flat surface.</p> 
<ol style="list-style-type: none"> 1) Install the mounting plate and mark places for the screws. Pre-drill 3*1 mm holes for screws. 2) Cut the cable opening in bottom of the panel. 3) Install the mounting plate. 4) Slide the panel in place from the top down. 5) Remove the display protection tape. 	<ol style="list-style-type: none"> 1) Install the mounting plate and mark places for the screws. Pre-drill 3*1 mm holes for screws. 2) Drill 12 mm hole for the cable. Draw and check hole location before drilling, it should not be visible when panel is mounted. 3) Install the mounting plate. 4) Slide the panel in place top-down. 5) Remove the display protection tape.

	<p>Cable connection</p> <p>Please note that cable connector release pin is positioned as in the picture, when connecting cable into panel. (Soft "click" sound can be heard when cable is connected.)</p>
	<p>Cable release</p> <p>Press connector release clip (shown in the picture) before pulling the cable out.</p>

3008 Control Panel basic features

Advanced Control Panel

Before using the Control Panel ensure it is assembled correctly with the assembly plate (see assembly instructions from sales package) and connected to the Wallas unit. This manual refers to Control panel SW 1.2.75. and heater SW 1.6.64

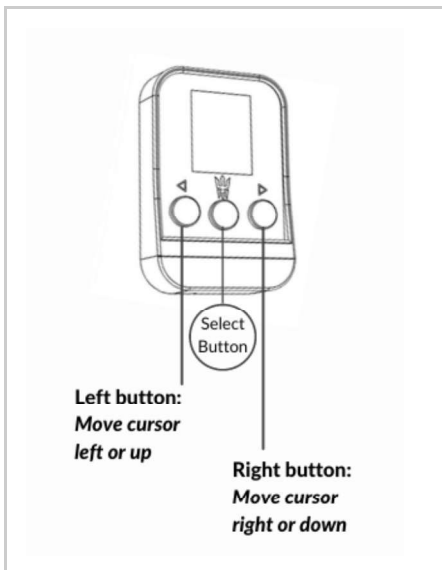

Starting the heater for the first time after power is connected or reconnected

Panel will display a black & white intro menu.

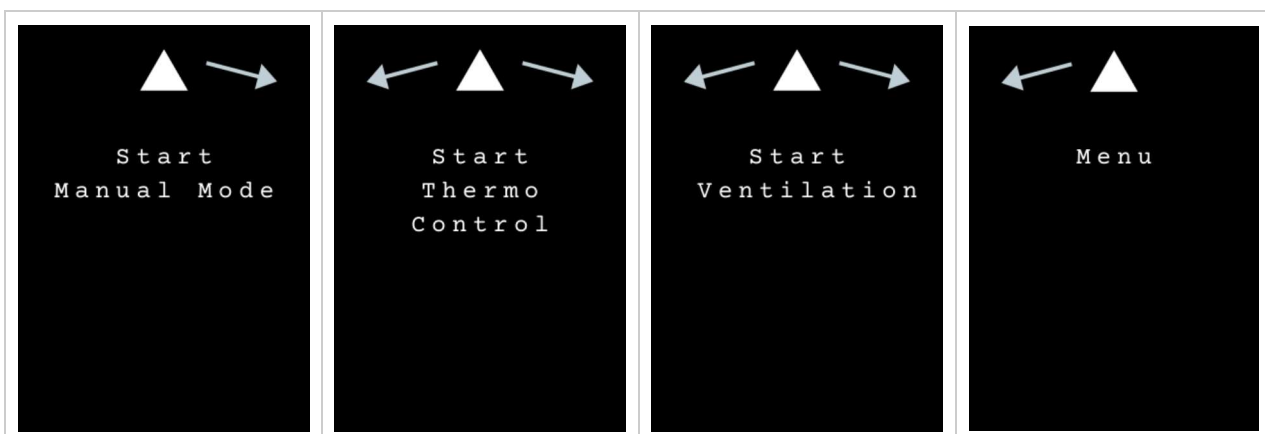

Before starting, choose the operation mode using the right and left buttons; Manual Heating Mode, Thermo Control Heating Mode or Ventilation Mode.

Use the arrow buttons to choose the mode you want and press the Select Button.



Once running in any mode, the system must be shut down completely before changing to another mode.

Starting the heater for the first time after power is restored

 <p>Start Thermo</p> <p>Long press to start</p>	 <p>Set Adjust 20 °C</p>
<p>If Thermo Control Mode is chosen, press and hold the Select Button for 3 seconds to start the heater (safety feature).</p>	<p>Use Arrow Buttons to set the desired temperature and press the Select Button. Main panel display will appear.</p>

Note: Wallas unit should start heating at about 5 minutes of running, while completing the starting process takes approximately 12 minutes.

Digital Panel Legend:

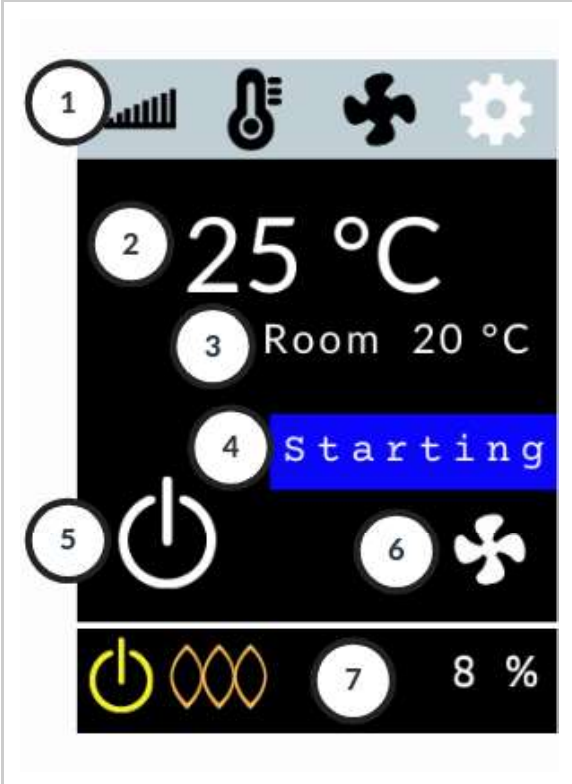
	<ul style="list-style-type: none"> 1 Main Menu Bar 2 Target Temperature , Power Level or Blower Speed 3 Room Temperature (°C or F available) 4 Heater Status 5 Start/Stop Icon (white Icon Off, orange Icon On) 6 Air Boost Icon 7 Info Bar: Power On/Off, Combustion, Info, Lock, Heater power %
--	--

Operation modes (Main Menu Bar)

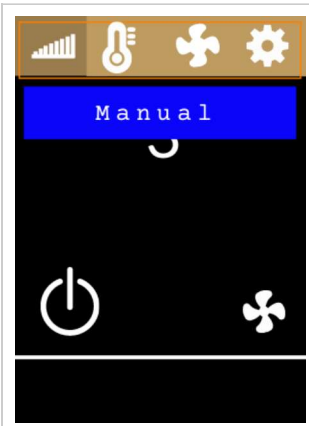
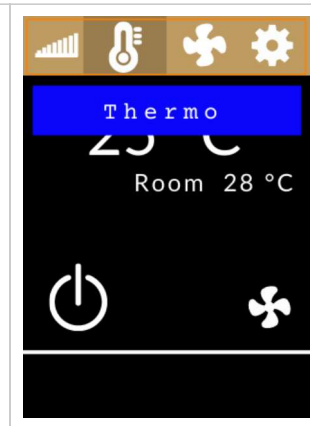
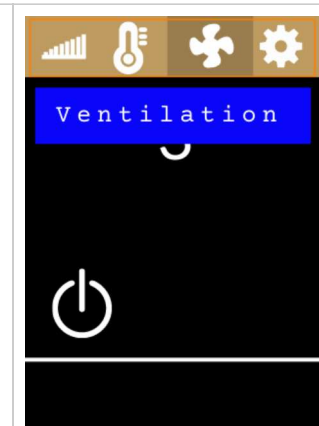
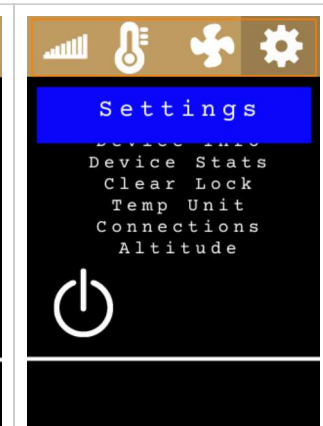
			
<p>Manual control mode - heater power is manually controlled with 6 power levels (1-6)</p>	<p>Thermo control mode - set a target temperature (°C/F) - heater controls the power level automatically</p>	<p>Ventilation mode - set the desired blower speed (speed levels 1-6) - blows fresh air without heating</p>	<p>Settings - get familiar with the control panel's functionality - read more under Settings</p>

Ignition

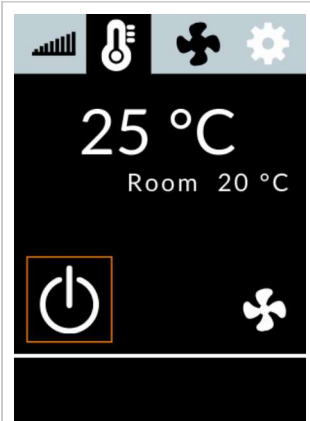
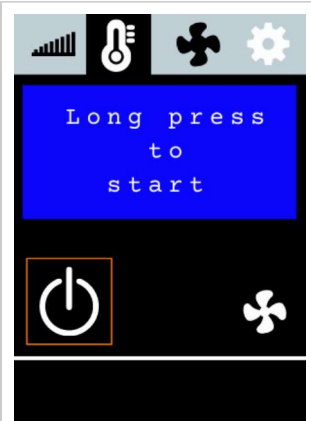
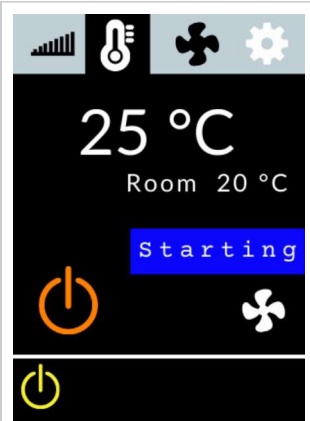
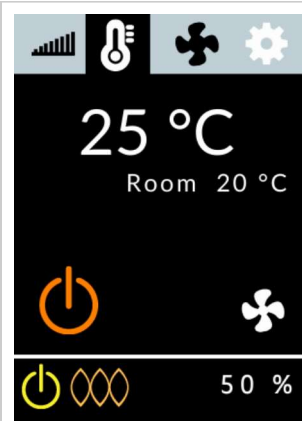
			
<p>To start, use the Arrow Buttons (left or right) to move the orange selection square to the white Start/Stop Icon.</p>	<p>Confirm the selection by holding the Select Button down for 3 seconds (safety feature). White icon turns orange.</p>	<p>Starting will appear on the screen.</p>	<p>The light orange combustion light will light up when the burner flame has been ignited and the combustion has stabilized (in about 5 min). Heater will be fully operational about 10 minutes later.</p>

Temperature/Power setting

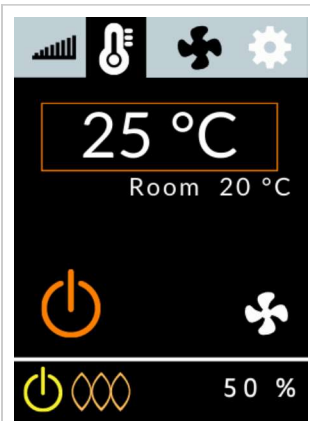
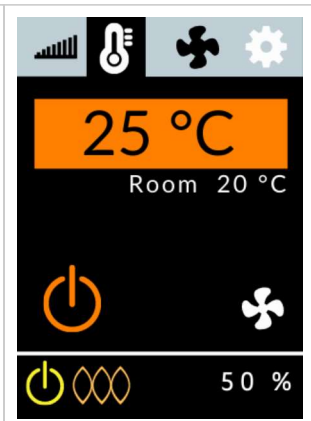
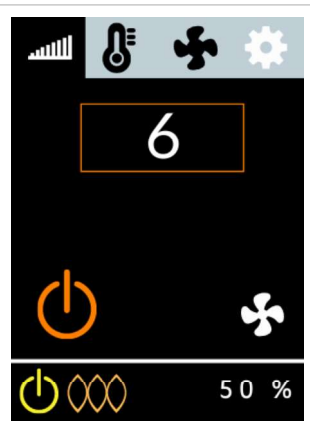
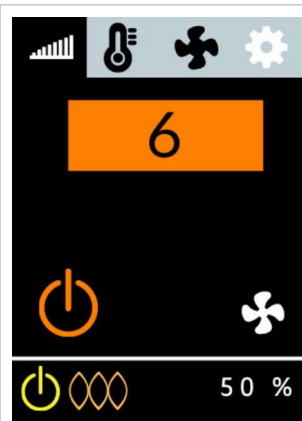
			
<p>In Thermo Control Mode, move the selection square to the Target Temperature and press the Select Button.</p>	<p>Press Arrow Buttons (left or right) to set the desired target temperature.</p>	<p>In Manual Mode, move the selection square to the Power Level and press the Select Button.</p>	<p>Use Arrow Buttons to set the desired power level (1-6). Confirm by pressing the Select Button.</p>

Air Boost

The Air Boost feature maximizes the air volume for quick defrosting and drying, but does not change the set temperature, power level of fuel rate. Air Boost can be activated either in Manual or Thermo Control Mode, when the system is heating.

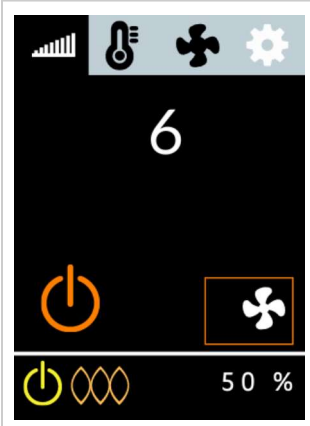
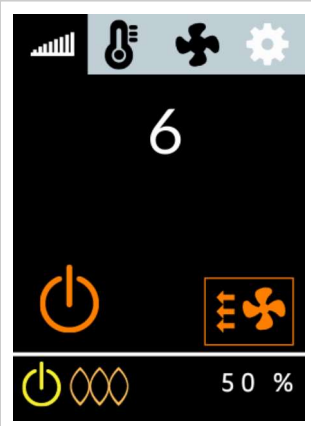
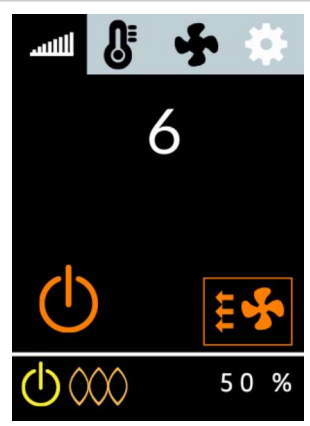
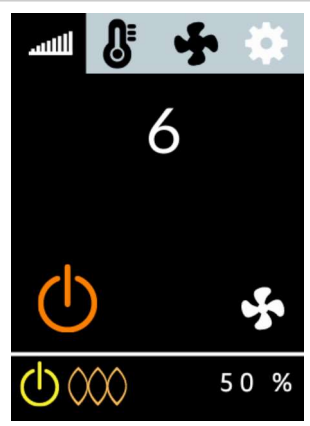
			
<p>Use Arrow Buttons to move the selector to the Air Boost icon and press the Select Button.</p>	<p>The orange Air Boost On icon will appear.</p>	<p>To go back to normal air volume, choose the Air Boost icon again and press the Select Button.</p>	<p>The Air Boost icon will change to white.</p>

Ventilation mode

Ventilation Mode blows fresh air without heating at 6 blower speeds. Choose Ventilation Mode prior to starting the device.

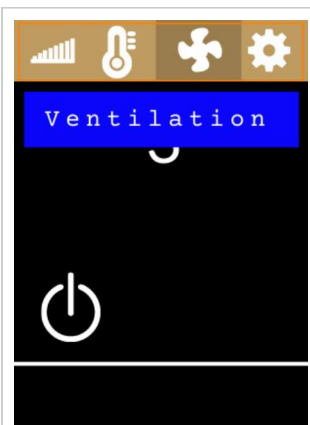
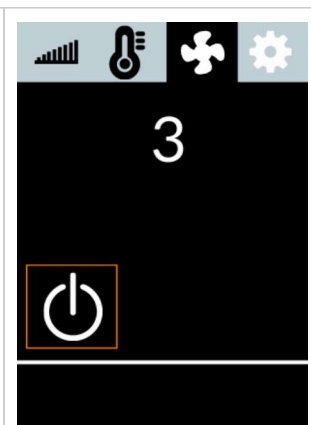
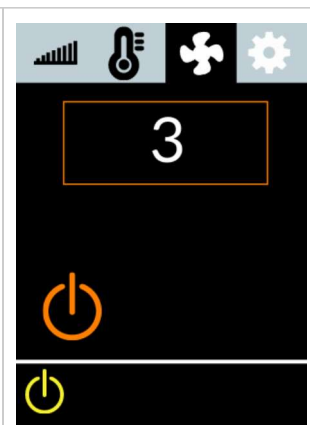
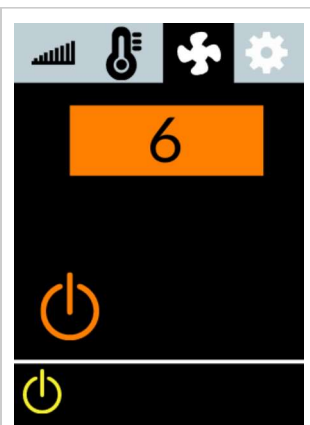
			
<p>Use the Arrow Buttons to move the selection square to the Main Menu Bar and press the Select Button to activate it. Use Arrow Buttons to choose Ventilation Mode and press the Select Button.</p>	<p>Move the selection square to the Start/Stop Icon and press the Select Button once. Press the Select Button down again for 2 seconds to confirm and start the heater. Yellow Power On light will appear in the Info Bar.</p>	<p>Choose the blower speed (1-6) by moving the selection square to the Blower Speed and press Select Button to activate the field.</p>	<p>Press Arrow Buttons to the desired power and press the Select Button to choose. To deactivate ventilation, turn the heater off. Re-start in the desired mode.</p>

Pause Mode (in Thermo Control Mode only)

Pause Mode automatically turns the heater off if the temperature remains +2 °C (3,6 F) above the set level for 1/2 hour due to local ambient conditions. Pause Mode can be delayed temporarily by slightly increasing the target temperature. Power can be turned on by increasing the target temperature in the Pause Mode.

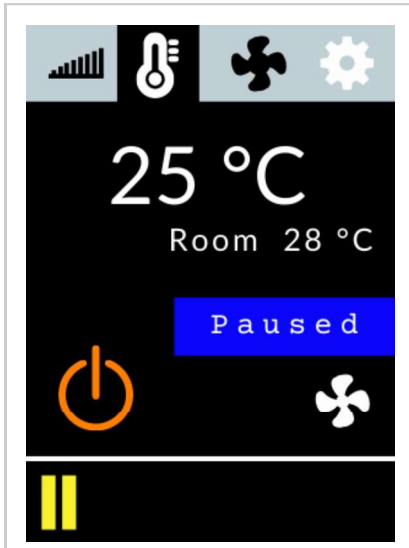

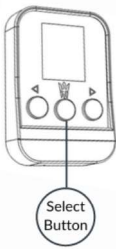
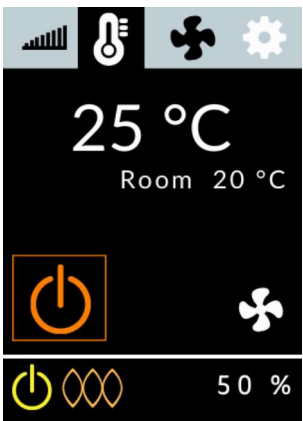
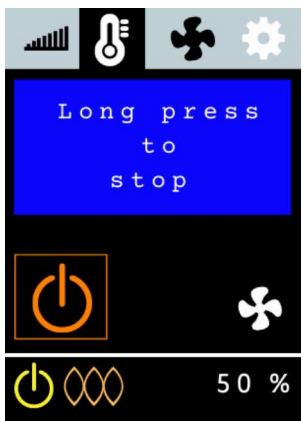
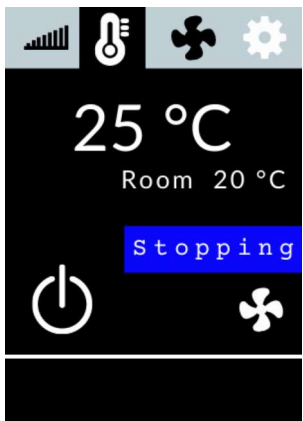

If the heater is in Pause Mode, *Paused* will appear on the screen. Heater will re-start heating again automatically, if the cabin temperature falls 2 °C (3,6 F) below the set target temperature.

Shut down

			
<p>Option 1 Quick shut down: Press and hold the Select Button down for more than 4 seconds. <i>Stopping</i> will appear and the Power Icon light will change to white indicating the unit is off.</p>	<p>Option 2 Alternatively use the Arrow Buttons to move the selection square to the Start/Stop Icon and press the Select Button.</p>	<p>Press and hold the Select Button down for more than 3 seconds and release.</p>	<p>Stopping will appear and the Power Icon light will change to white indicating the unit is off.</p>

Note: The system mode that was used last upon shutdown will be the same mode when the heater is turned on again.

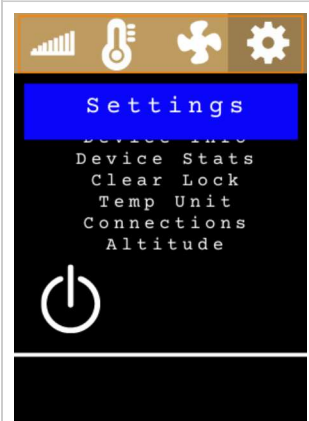
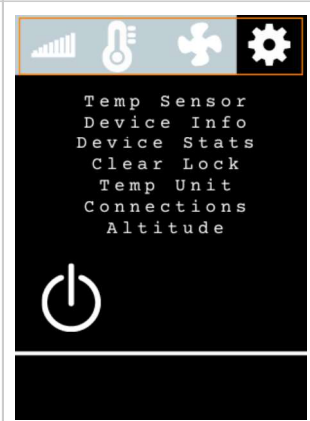
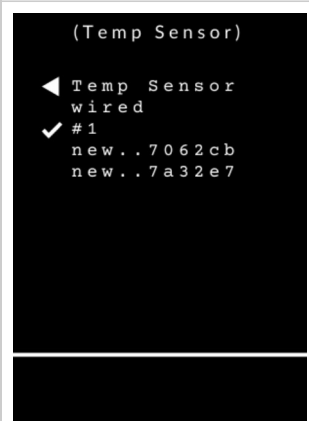
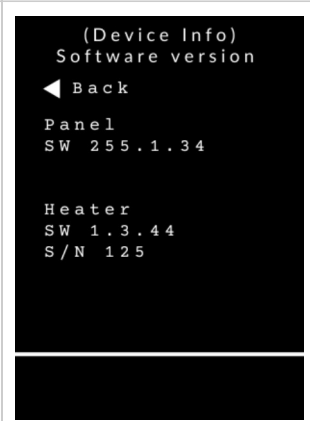
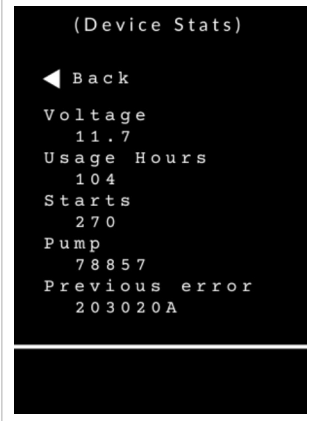
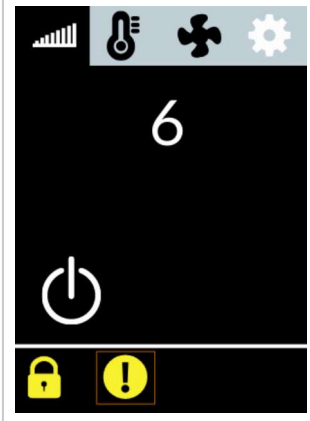
Settings:

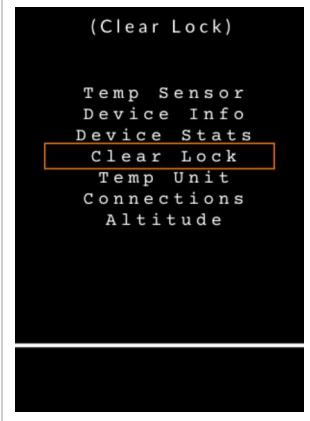
			
<p>Move the selection square to the Main Menu Bar and press the Select Button. Use the Arrow Buttons to choose Settings. Press the Select Button.</p>	<p>Use the Arrow Buttons to move the selection square down and press the Select Button to choose.</p>	<p>Temp Sensor</p> <ul style="list-style-type: none"> - Choose the desired sensor to measure the indoor temperature with. - Wired is the hardwired sensor in the heater unit - Wireless sensors are listed by sensor numbers - When a wireless sensor is selected, it gets a running number ID 	<p>Device Info</p> <ul style="list-style-type: none"> - Control panel and heater software versions (needed for customer service/tech help) - Heater unit serial number (needed for customer service/tech help)
			
<p>Device Stats</p> <ul style="list-style-type: none"> - Check there is enough voltage to start the unit (must have at least 10 V) - Check usage hours (units must be serviced every 2000 hours/3 years) - System starts - Pump cycles since new - Previous error code 	<p>If a Lock Icon is displayed, the heater has locked itself for safety. The heater will also lock after 3 unsuccessful starts. Move the selection square to the Exclamation Point Icon and press the Select Button. An error Page will appear.</p>	<p>If the heater has locked itself, there may have been a failure that should be investigated and resolved prior to further use. The error page will display a check list and a website for further information. If you need help, reach out to a professional.</p>	<p>To remove the lock, move the selection square to the Main Menu Bar and press the Select Button, choose Settings, and press the Select Button. Choose Clear Lock from the Settings Menu and press the Select Button.</p>



<p>(Temp Unit)</p> <p>◀ Temp Unit</p> <p>✓ °C</p> <p>°F</p>	<p>(Connections)</p> <p>◀ Connections</p> <p>Remove all</p>	<p>(Altitude)</p> <p>◀ Altitude</p> <p>✓ Normal</p> <p>Hill</p> <p>Mountain</p>	<p>Note! Altitude setting must be made before starting the heater.</p>
<p>Temp Unit - select temperature unit Celcius / Fahrenheit.</p>	<p>Connections - clear all paired mobile phone devices.</p>	<p>Adjust combustion in high altitudes. Heater operation can be optimized to different altitudes.</p>	

Wallas Remote application and Control Panel connection

Local Connection

Advanced Control Panel can be connected into the mobile application with local connection. You can then operate your heater with the "Wallas Remote" application. First, download the "Wallas Remote" application to your mobile device from your application store.

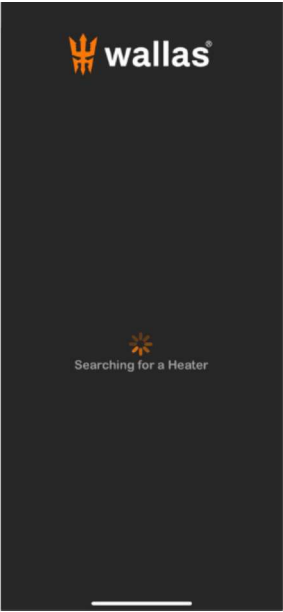
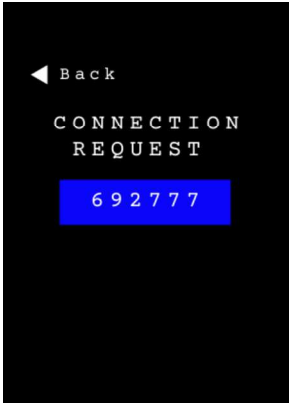
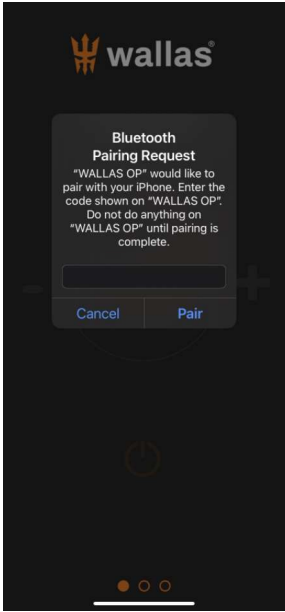

Pairing the app with the heater

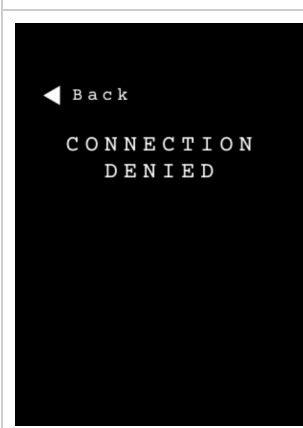
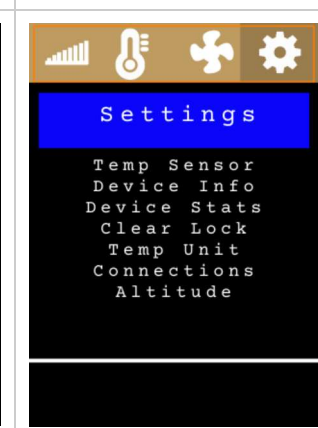
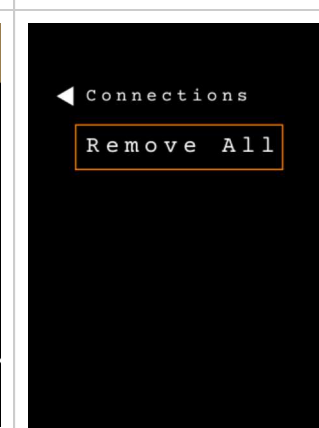
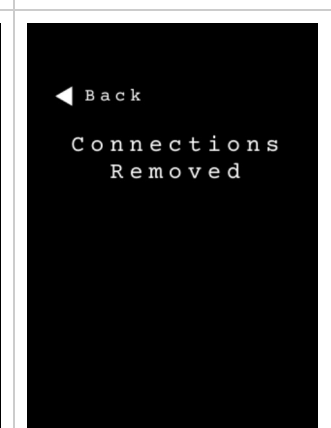
Mobile Device	Advanced Control Panel	Mobile Device	Advanced Control Panel
			
<p>Turn the short range wireless connection on your mobile device for pairing the app with the control panel. When you open the app for the first time, it will search for a Wallas heater nearby.</p>	<p>When a heater is found , a pin code will appear on the screen of the Advanced Control Panel.</p>	<p>Type the pin code in the app and press Pair to continue. Note! In some phone models Pairing request will open in background info window.</p>	<p>Once the pairing has been successful, it is confirmed on the Control Panel with <i>Device Added</i>.</p>

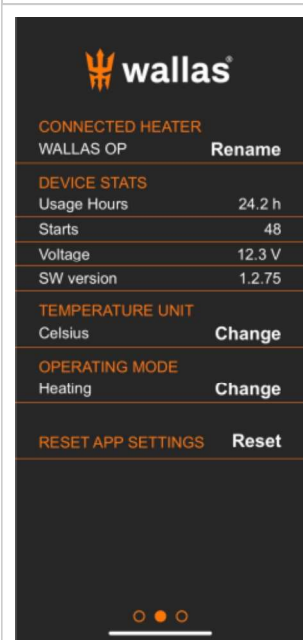
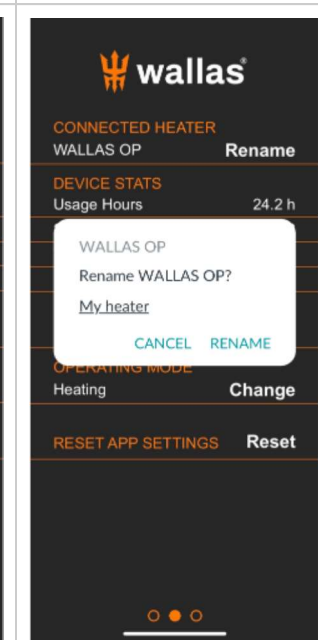
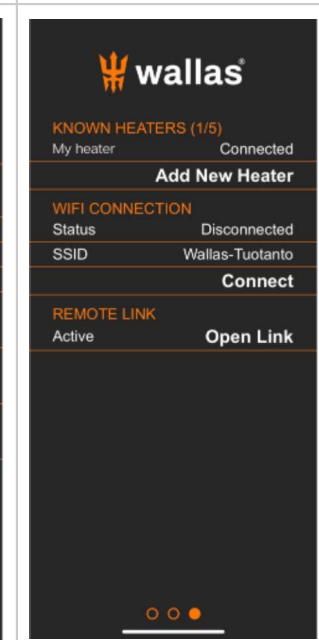
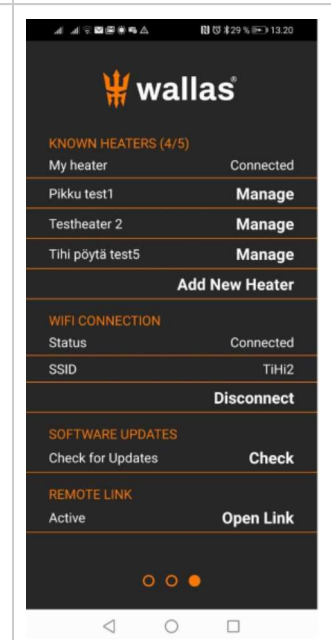
Advanced Control Panel	Advanced Control Panel	Advanced Control Panel	Advanced Control Panel
			
<p>If the connection was not successful, <i>Connection Denied</i> will appear on the Control Panel.</p>	<p>Use Arrow Buttons to go to the Main Menu Bar and press the Select Button. Go to the Settings and press the Select Button.</p>	<p>Choose Connections and press the Select Button. Select Remove All and press the Select Button.</p>	<p>Turn the app off, open it again and repeat the pairing process.</p>

Mobile Device	Mobile Device	Mobile Device	Mobile Device
			
<p>When the heater is connected for the first time it will be named by Wallas OP.</p>	<p>Each heater/connection can be renamed (max 20 characters).</p>	<p>User can add new heater and repeat the pairing process with the new heater.</p>	<p>Application supports up to 5 different heater connections. It is also possible to pair same heaters with another mobile device but only one active user (active connection) is possible at a time.</p>

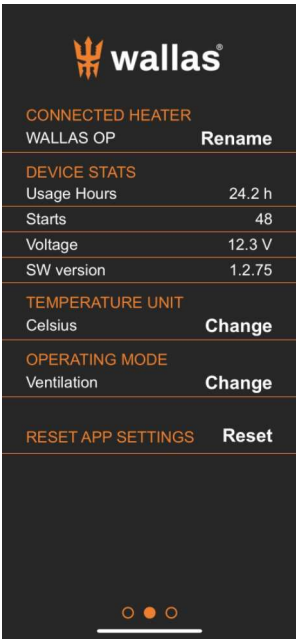
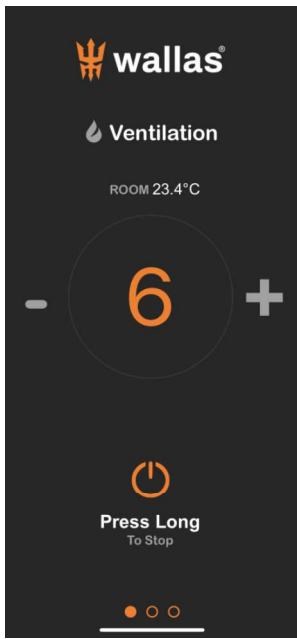
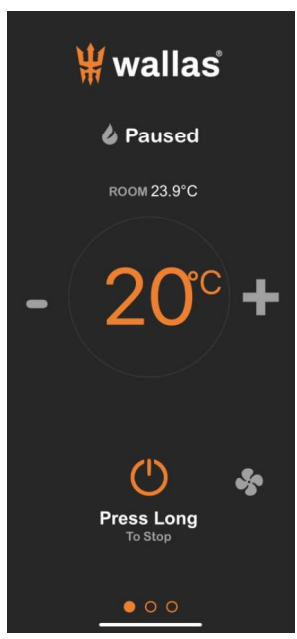
Operating Mode	Ignition	Temperature	Air Boost
			
<p>Heater can be started from application in two modes: Heating/Thermo Control: Set a target room temperature C°/F° Ventilation: Blow fresh air without heating Prior to starting the heater, choose mode by swiping the screen to the 2nd page and tap Change under Operating Mode to set the desired mode (Heating or Ventilation). Due to safety, heater cannot be started remotely in Manual Mode. To switch between the modes, turn the heater off and start in the desired mode.</p>	<p>Press and hold the Start/Stop Icon for 2 seconds to start the heater.</p> <p><i>Starting</i> will appear on the screen. Orange combustion light will light up when the burner flame has been ignited and the combustion has stabilized (approx. in 5 min). Heater will be fully operational about 10 min later. Heater starts in Thermo Control Mode.</p>	<p>In Heating/Thermo Control Mode the thermostat can be set to a target room temperature.</p> <p>Press the Minus or Plus Icons to adjust the temperature to the desired level.</p>	<p>Air Boost maximizes the air volume for quick defrosting and drying, but does not change the set temperature.</p> <p>While the system is heating, press the Air Boost Icon until the orange Air Boost light appears. To go back to normal air volume, press the Air Boost Icon again. The light will turn off.</p> <p>Be aware that when running in Air Boost mode, the system amperage draw will be quite high, so use it with care if DC power is limited.</p>

Ventilation	Ventilation	Pause	Shutdown
			
<p>Ventilation mode blows fresh air without heating with 6 blower speeds.</p> <p>Swipe the screen to the 2nd page and tap on Change under Operating Mode until you see Ventilation. It is now set and you can start the heater as usual (see ignition).</p>	<p>Press and hold the Start/Stop Icon down for 2 seconds to start the heater.</p> <p>Press Minus or Plus icons to set the desired power for the fan (1-6).</p> <p>To deactivate Ventilation Mode turn the heater off. Re-start in the desired mode.</p>	<p>Pause Mode automatically turns the heater off if the temperature remains +2° (3 F°) above the set level for 1/2 hour due to local ambient conditions.</p> <p>If the heater is in Pause Mode, <i>Paused</i> will appear on the screen.</p> <p>Pause Mode can be turned off temporarily by slightly increasing the target temperature. Heater will re-start heating again automatically, if the cabin temperature falls 2 degrees (3 F°) below the set target temperature.</p>	<p>Press and hold the Start/Stop Icon down for 2 seconds.</p> <p><i>Stopping</i> will appear and the Start/Stop icon will turn white indicating the unit is off.</p> <p>Note: The heating mode that was used last upon shutdown will be the same mode when the heater is turned on again.</p>

WiFi Connection

The 3008 Control panel can be connected to the internet with a WiFi connection.



You can then operate your heater with the "**Wallas Remote**" application through the Internet.

Wifi connection is created through the Wallas Remote application. (Local connection between application and Control Panel must be available before setup)

The first time selecting Connect, the application will ask for SSID and Password. Application will share this information with Control Panel.

NOTE! "Open" WiFi or "no-password" networks will not work with the Wallas system.

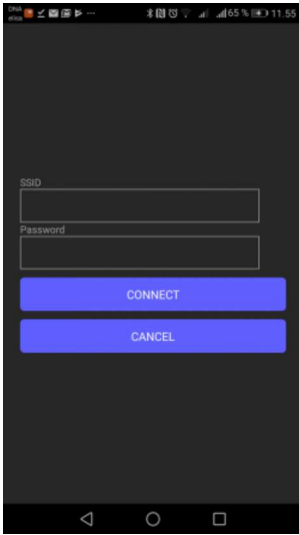
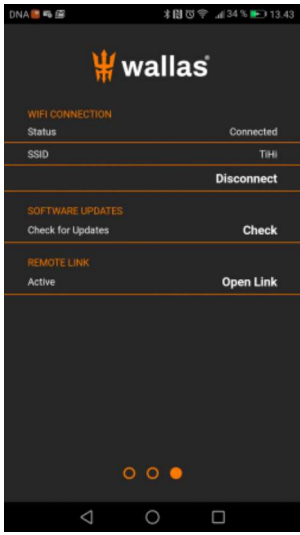
NOTE! If you sell your heater or give it away, you need to clear WiFi settings. (SSID="empty", password="empty") and you should remove the Wallas application from your device.

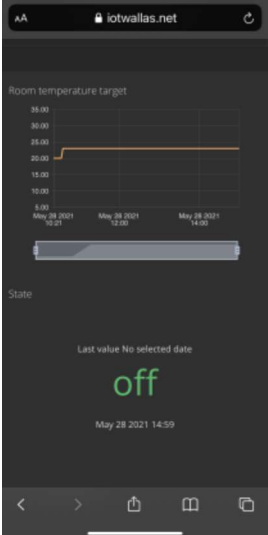
			
<p>Feed your internet connection details.</p>	<p>When internet connection is finalized status will be "connected". After few minutes "REMOTE LINK" will appear.</p>	<p>"REMOTE LINK " display will connect to internet panel. You can : - set room temperature target - start /stop your heater Note: heater start and stop takes several minutes.</p>	<p>You can see when heater was last connected into internet, and what the heater state is. You can see some statistics of your heater. Available graphs will vary depending of your heater model.</p>

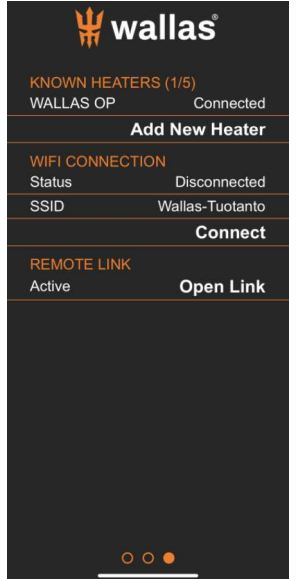
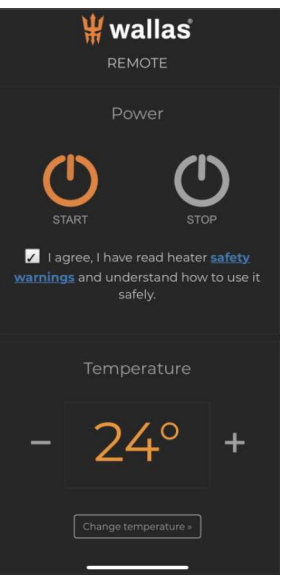
	
<p>When you start application and heater is not in range you can operate heater by opening the "Remote Link".</p>	<p>Note! Before you can operate heater, you need to read safety warnings and agree.</p>

Wallas-Marin reserves the right to develop usability and features of the application.

Connections tips:

1. Read from your mobile device user guide how connections and WiFi connections are managed in your device.
2. Make sure that local connections and WiFi are allowed in you mobile device (airplane mode is OFF).
3. Your mobile device is not in power save mode and location permission is given to Wallas application.
4. Check that heater is connected to power and Control panel is connected via cable to the heater.
5. Distance between Mobile device and Control Panel is not too long.
6. Control Panel is not in use by another person. Only one local connection is possible at a time.
7. If your mobile device already has connection to the heater it can not create new connection before the old connection is removed from your device. In some phone models this has to be made manually. Remove "WALLAS OP" from your phones paired short range wireless connection devices list (note there might be several OP pairings in mobile device list, remove all) and restart short range wireless connection before new pairing is possible. This may be the case if control panel pairing code only blinks fast and your mobile device is repeating the connection requests.
8. Change connection to other Wallas heater.
 - Close Wallas remote application.
 - Remove old connections from your mobile device short range wireless connection paired devices list. Restart your devices short range wireless connection.
 - If there is no other users for new Wallas heater you can select Control panel menu Settings/Connections/Remove all.
 - Restart application.
 - When/if "Change Device " link appears (30-60 sec) press the link.
 - Wait connection procedure to finalize.
9. In some phone models Pairing request will open in background info window. (See your mobile devices user guide.)

Software update

It is recommended to check software updates and perform software updating regularly to ensure optimal performance of the device.

Preparations for software update

1. check that the device and the cell phone have sufficient level of power in battery
2. check that the WiFi signal is strong and the internet connection is reliable
3. be prepared to disconnect control panel cable, or power of the device to make master reset to the system if necessary



Software update is a complex process, and errors may happen if there is a power or network failure during the update, including complete system failure. Therefore it is forbidden to start software update for control panel if the Wallas heater is the only heat source and being unable to start heater would create a danger.

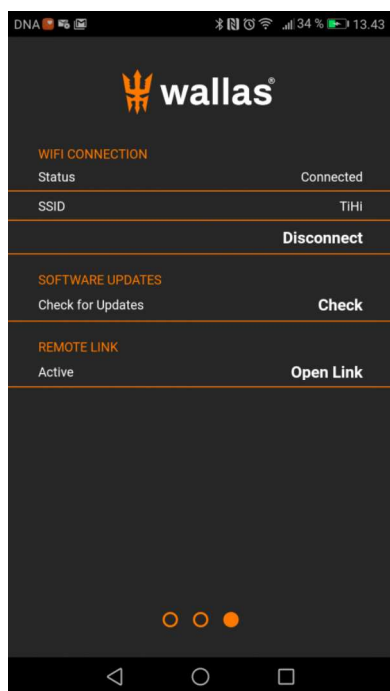

For software update make sure that

- WiFi signal is strong and the internet connection is reliable
- WiFi HotSpot name (SSID) is visible in application page and the status is "Connected"
- the heater is "OFF" before starting the update

Updating may take up to 6 minutes, depending on network and connection.

If new software version is available *Update link* will appear on the screen. Select update.

Do not close application or power from the heater/stove while update is ongoing.

Control panel display will close and start a few times during the update.

After the update is done, control panel will start and application will reconnect to panel.

Note: In some phone models you may have to do the pairing again after software update.

Possible problem/error	Solution
<i>File error</i> message appears	Start update again after few minutes
Software update stops during download	<ol style="list-style-type: none"> 1. Close the application 2. Restart the short-range wireless connection from your mobile device 3. Start update again <p>Tip! Find different location, where WiFi signal is better or WiFi hotspot has a better connection</p>
Control panel is jammed	Disconnect panel cable and try again after few minutes

Error Codes

Possible error codes are listed on the table below.

Combined Code	Error message	Problem	Troubleshooting
10A06	Ignition failed	Ignition failed, maximum allowed number of pump pulses	Check the fuel, check the fuel filter, tighten all joints.
1020B	Low voltage	Supply voltage is below minimum	Renew/charge the battery.
10001	System error		Contact service
10003	System error		Contact service
10201	System error	Unexpected flame-out	Check the fuel level, check the fuel filter.
10206	Ignition failed	Preheating failed, residual fuel burning for too long	Try to start again, if same fault, contact service.
20005	System error		Contact service
20A0207	System error	Water thermostat is missing water temperature data	Contact service
20B0205	System error	Analog control (potentiometer) is missing	Connect the controller, check control panel wiring.
203020A	Ignition failed	No fuel was detected, maximum allowed number of pump pulses	Check the fuel, check the fuel filter, tighten all joints.
2010204	Combustion fan	Burner fan is not working (no tachometer signal)	Contact service
2020204	System error	Ventilation fan is not working (no tachometer signal)	Contact service
2030204	System error	Fuel pump output short-circuit	Fuel pump wires are in shortcut, check the wiring.
2030205	System error	Fuel pump not connected (no current detected on output)	Fuel pump is missing, connect fuel pump connector.
2040205	Water pump	Water pump is missing (no load on output)	Connect the water pump connector.
2050204	System error	Burner or ventilation fan power short-circuit	Contact service
2060204	Glow plug	Glow plug short-circuit	Renew the glow plug.
2060205	Glow plug	Glow plug missing (no current detected on output)	Renew the glow plug, check that the glow plug connector is connected to the ECU.

2070005	System error		Contact service
2080001	System error		Contact service
2080006	System error		Contact service
2080008	System error		Contact service
2080208	System error		Contact service
3000007	Burner temp sensor	Burner temperature is missing/invalid	Contact service
3010007	Air temp sensor	Air temperature is missing/invalid	Connect air temperature sensor.
3010202	Air overheat	Air temperature is too high	Check air vent's and warm air hoses for blockages.
3020004	Warning	Hot water target should not be set higher than coolant target	Adjust the hot water target from settings
3020007	Water temp sensor	Water temperature is missing/invalid	Contact service
3020202	Coolant overheat	Coolant temperature is too high	Coolant is not circulating, bleed the air out of the system, check the coolant pump.
50001	System error	CAN bus other errors	Contact service
50006	System error	CAN bus timeout error	Contact service
50008	System error	CAN bus busy error	Contact service
7020B	Low voltage	Cannot start, low voltage	Renew/charge the battery
7020C	System error	Cannot start, device locked	Open locking mode from the control panel, check control panel user manual.
7020D	System error	Cannot start, enable input not asserted	Enable wire is missing, connect the enable wire or set the main power ON
7020E	System error	Cannot start, burner temperature missing or too high	Powercut during the operation, Wait that unit cools down and try to start again.

Installation check list

Installation check list before test-run

Installation
<ul style="list-style-type: none"> • Read manual and use only official Wallas parts • Ensure that the boat/cottage/location is sufficiently ventilated. • In boat heaters the exhaust pipe outlet must be at least 400mm (16") away from the opening for filling fuel or tank breather. • We recommend installing the control panel on a vertical surface where liquids are not able to leak into the switch and it is out of reach of children.
Fuel system
<ul style="list-style-type: none"> • Fuel for the device comes through a separate tank fitting, not via a manifold or connection shared by the engine or other device. • Install the filter to the fuel hose before you install the device, in an accessible location for filter changes. • Fasten the fuel hose couplings tightly. Always use a sleeve joint on the hose (olive ring). • Make sure that the surfaces of the couplings are clean before fastening them. • The hoses must be kept clean during installation. • If the surface of the fuel tank is above the device, a magnetic valve must be installed into the fuel hose close to the tank. • Cut the fuel hoses to the appropriate length when installing them.
Electrical installation
<ul style="list-style-type: none"> • The nominal voltage of the device is 12 VDC. • Current for the device is taken directly from the battery terminals using cables that are as short as possible. • Put the main fuse of c. 15 A on the + cable close to the battery.
Exhaust
<ul style="list-style-type: none"> • Make sure the inner exhaust hose (1028) is longer than the outer in both ends. • If there is a possibility for water to enter the exhaust hose, use a drainage lock (2471) and always make a goose neck in the exhaust hose. • The exhaust lead through must be installed at least 400mm from fuel fill cap and fuel breather nozzle, 500mm over the water line and far away from any fresh air intake. • If the heater is used in extreme conditions (extreme cold or heat), consult a local Wallas-dealer on installation. • Use only lead-throughs approved in this manual. Wrong exhaust lead through may lead to dangerous gasses entering the heater and/or living spaces. • Do not insulate coaxial exhaust hose entirely. Only insulate parts of the hose that touch flammable materials. <p>Insulating the whole hose damages burner fan.</p> <ul style="list-style-type: none"> • The exhaust pipe must not come into contact with combustible materials. Insulate the exhaust hose with heat insulation sock (1050), only if it is necessary.
Exhaust fumes
<ul style="list-style-type: none"> • When choosing the outlet location, note that exhaust fumes are hot. • In boat heaters use a goose-neck in exhaust pipe to prevent splash water entering. • If your installation location is a boat with metal hull, the device and outlet must be insulated from the hull to prevent electrochemical corrosion.
Warm air outlet (Spartan and Viking models only)
<ul style="list-style-type: none"> • If your heater has air hosing, do not reduce air hosing too much. Recommendation of \varnothing 75 mm outlet is to divide it to two \varnothing 60 mm outlets. • It is recommend to insulate the warm air hoses to save energy. • Note! All warm air vents are not allowed to be closed at the same time.

Initial start-up



- The device usually does not start the first time after it has been installed. It may take several starts (c. 4-6) for the fuel hoses to fill up enough for the fuel to reach the burner.
- Watch the hoses as they fill up as you start the device.
- After two unsuccessful start-ups, the device will lock.
- Follow the instruction for unlocking the device and try again.
- When the device starts, look for possible leaks in the exhaust and fuel connections.
- Run the device for c. ½ hour to allow possible installation and manufacturing greases to burn off. Make sure there is enough ventilation.
- **NOTE! Remember to carefully read the instructions for installing, operating and servicing each device before installation.**

 **In metal-hulled boat**, you must ensure that the device, the flue gas lead-through, the fuel connection, the control panel and all other parts are insulated from the boat's hull. This must be done to prevent electrochemical corrosion and to prevent voltage from being transmitted the hull to the device or vice versa during electrical faults.

To be filled in by the installer

Test run performed	
Serial number	
Company	
Installer	
Installation date	
Signed	

Maintenance recommendations

	Service recommendation for the stove is 2000 operating hours or every 3 years, whichever comes first.
	Maintenance should be carried out by authorized Wallas service shop.

Special recommendations
Occasional (monthly) use of the device will increase reliability by purging old fuel. Observe fuel provider recommendation with regard to the fuel type, fuel life length, additives and moisture removal. If the device has a separate tank: When selecting the fuel type, take note of the temperature limits of each particular fuel.
Removal of the water from the tank
Isopropanol based anti ice detergent meant for gasoline cars (no ethylene or methyl based) will be added to the fuel during the season. It is useful to make the addition after each couple of tanks and in the beginning and end of the heating season. The anti ice detergent binds the condensed water and prevents the sediment and contamination during the summer. For the dosage, observe the recommendations given by the manufacturer of the agent.
Winter storage
If the device uses the same tank as the engine: <ul style="list-style-type: none">• Change the fuel filter.• Perform measures recommended by the boat/engine manufacturer to be performed before winter storage. If the device has a separate tank: <ul style="list-style-type: none">• Drain the fuel tank in the autumn.• Clean the tank and change the fuel filter.• Fill the fuel tank with fresh and clean fuel in the spring. For the device itself, you do not need to do anything.
Spare parts
Spare parts list, www.wallas.com

	An anti-freezing agent for diesel vehicles may increase the forming of scale at the bottom of the burner and therefore shorten the maintenance interval.
---	---

Warranty terms

Wallas-Marin Oy (the “Manufacturer”) warrants their heaters, stoves, and ovens (hereinafter referred to as the “Product”), against defects in material and workmanship for two (2) years or 2,000 operating hours in normal use (whichever comes first) effective at the time of sale to the Original End-User under the conditions provided herein.

Wallas-Marin heating systems are designed and intended for recreational use. Use for commercial, live-aboard or unattended use will result in elevated operating hours requiring maintenance and repair not covered by product warranty.

1)	This warranty is made only to the first purchaser/customer (“Original End-User”), who acquires the Wallas-Marin Product for their own use.
2)	This warranty will be in effect for two (2) years or 2,000 operating hours (whichever comes first) from the date of purchase by the Original End-User. A copy of the dated receipt of the sale should be retained as evidence of the date of purchase. The warranty period may be extended by an additional 12 months by registering the Product within three (3) months of the Product being sold to the Original End-User. Registration must be done online at www.wallas.fi/takuu . Despite the extended warranty period, coverage is limited to 2,000 operating hours for all Products. Repairs carried out during the warranty period do not renew or alter the original warranty period.
3)	The intent of this warranty is to protect the Original End-User of the Product from defects and provide repair and replacement of defective parts. Warranty repair service must be administered by an authorized Wallas-Marin distributor or an authorized Wallas-Marin Service Center in accordance with the Wallas-Marin warranty policy.
4)	Notification of the defect must be given in writing immediately to the authorized Wallas-Marin distributor, that sold the product (the “Seller”) by the Original End-User, if possible, but no later than two (2) months after the defect occurred. If the warranty period has expired and no notice was given in writing while the warranty was still valid, the defect will not be covered.
	The notification must include: <ul style="list-style-type: none"> • Description about the issue • Description about the installation, when, where, and by whom it was done (photographs may be included) • Product name, serial number, place and date of purchase
5)	For repairs under warranty, the Original End-User must take or package and ship the product to an authorized Wallas-Marin Distributor or to an authorized Wallas-Marin Service Center. The best location for repairs is determined by the importer after the Original End-User has notified the Seller about the issue. Once the Wallas-Marin Distributor/Service Center has examined the returned Product and if it is found that it was defective in material and/or workmanship, the Distributor/Service Center shall repair the product. If the distributor/Service Center determines that repairs must be made, only authorized Wallas-Marin parts will be used.
6)	This is a Return to Base Warranty, which does not cover costs accumulated from the removal and re-installation of the Product, or transportation costs if the Product has been shipped for repairs, or any damage occurred in transit.
7)	This warranty does not cover consumable or wear parts, which include glow coil/plug, bottom mat or wick, fuel filter, seals.
8)	This warranty does not limit the rights specified in the consumer protection legislation.

9)	<p>This warranty does not cover indirect damages arising from a defective Product, property damage, loss of revenue, injury or loss of life as a result of system failure, or conditions unrelated to the material and workmanship of the Wallas-Marin Product.</p> <p>Such unrelated conditions include, but are not limited to:</p> <ul style="list-style-type: none"> a) The Product has not been installed according to the Wallas-Marin Product User Manual or the country-specific regulations have not been followed. b) Damage or failure caused by installation of accessories or components not manufactured or approved by Wallas-Marin and/or modification of the Product structure without the consent of the Manufacturer. c) Failure to follow the operation or maintenance instructions in the Product User Manual. d) Damage caused by inappropriate storage or transport. e) Fault resulted by an accident or damage of which Wallas-Marin had no control over (force majeure). f) Damage or failure caused by improper handling, use of unsuitable fuel, low voltage, excess voltage, dirt, water penetrating the Product, galvanic corrosion, electro chemical corrosion or damages due to stray current. g) The Product has been dismantled or opened without the explicit permission of the Manufacturer/Importer. h) Non-Wallas components or spare parts have been used in the repair of the Product. i) Repair was done by an unauthorised service provider. j) Installation error when possible leaking water or leaking coolant can enter the boat/vehicle/RV/building structures.
10)	<p>Wallas-Marin reserves the right to change the design of any Wallas-Marin Product without notice and with no obligation to make corresponding changes in Wallas-Marin products previously manufactured.</p>

	<p>When making a warranty claim, the Original End-User must provide proof that the maintenance and safety instructions have been thoroughly followed. This warranty does not apply to defects which have arisen due to carelessness in following installation, operation, and maintenance instructions.</p>
--	--

Disclaimers

<p>The manufacturer is not liable for damage caused by improper use or incorrect operation or installation. Failure to comply with the installation, operation and service instructions makes the guarantee null and void and this leads to the exclusion of any liability of Wallas-Marin Oy.</p>
--

Wallas - Spartan Air

Wallas-Marin Oy

Kärriykatu 4

20780 Kaarina

inland

<https://www.wallas.fi/>

service@wallas.fi

Lataa viimeisimmät käyttöohjeet täältä <https://wallas.fi/index.php?id=246>

See and download the latest manuals from here <https://wallas.fi/index.php?id=246>

Oikeudet muutoksiin pidätetään.

Vi behåller rätten att göra ändringar.

We reserve the right to changes.

Änderungen vorbehalten.

Nous nous réservons le droit de faire des changements.

Wij behouden ons het recht voor deze te wijzigen.

Ci riserviamo il diritto di apportare modifiche.

Vi reserverer oss retten til endringer.